

Optical Emission Spectrometer

PDA-7000 Series



From Shimadzu, which has progressed in parallel with the Japanese metals industries

Combines the best of each Shimadzu Optical Emission Spectrometer

PDA-7000 Series

Shimadzu's Optical Emission Spectrometers developed in parallel with the Japanese metals industry.

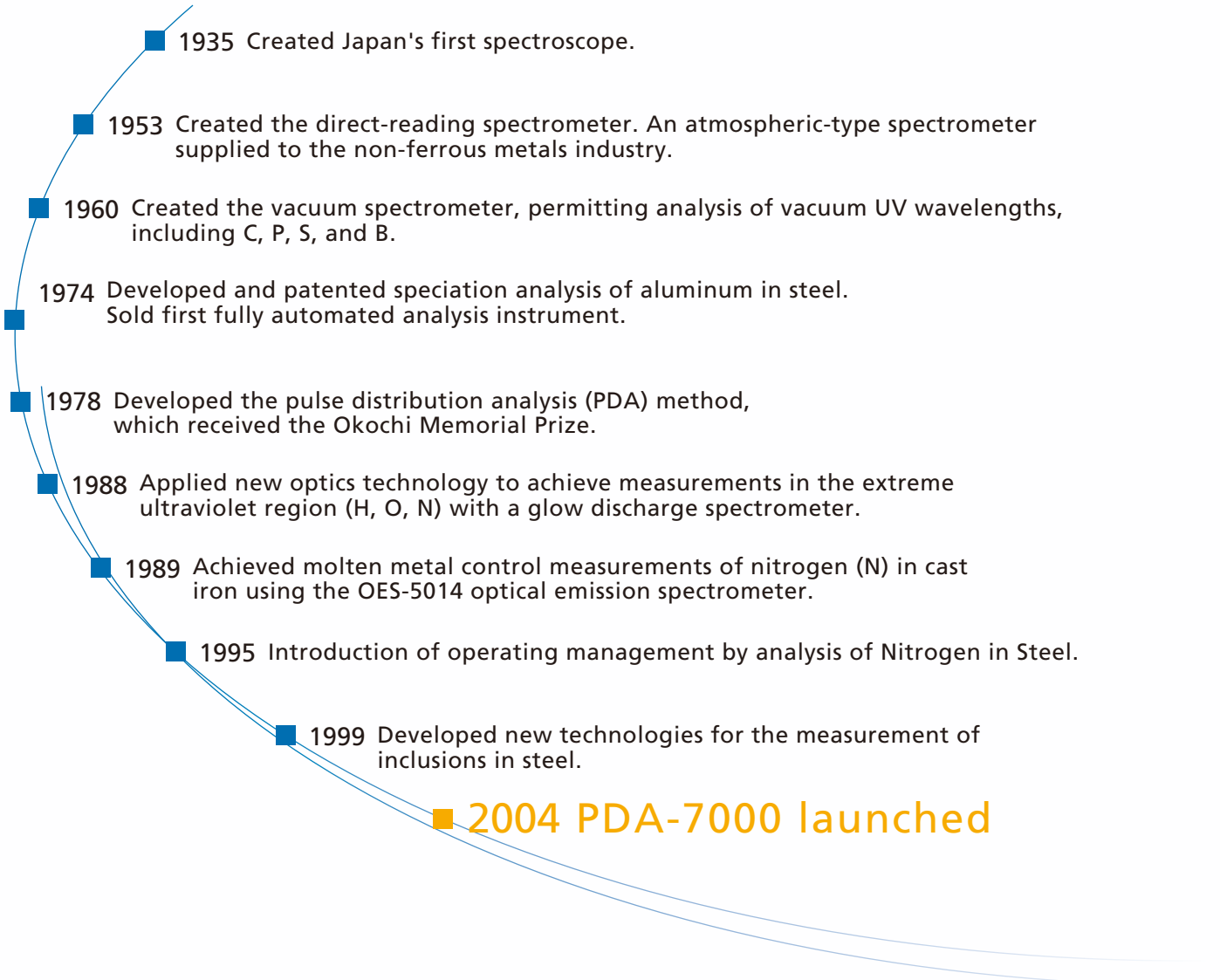
- 
- 1935 Created Japan's first spectroscope.
 - 1953 Created the direct-reading spectrometer. An atmospheric-type spectrometer supplied to the non-ferrous metals industry.
 - 1960 Created the vacuum spectrometer, permitting analysis of vacuum UV wavelengths, including C, P, S, and B.
 - 1974 Developed and patented speciation analysis of aluminum in steel. Sold first fully automated analysis instrument.
 - 1978 Developed the pulse distribution analysis (PDA) method, which received the Okochi Memorial Prize.
 - 1988 Applied new optics technology to achieve measurements in the extreme ultraviolet region (H, O, N) with a glow discharge spectrometer.
 - 1989 Achieved molten metal control measurements of nitrogen (N) in cast iron using the OES-5014 optical emission spectrometer.
 - 1995 Introduction of operating management by analysis of Nitrogen in Steel.
 - 1999 Developed new technologies for the measurement of inclusions in steel.
 - 2004 PDA-7000 launched



For many years, Shimadzu has supplied the world with the Optical Emission Spectrometer instruments that are indispensable for the quality control of metals.

Shimadzu now presents the PDA-7000, which combines the best of all these instruments.

Shimadzu's unique time-resolution PDA photometry is installed as standard feature so as to provide powerful backup for quality control analysis.

Features of the PDA-7000 Series

High-sensitivity Analysis of Nitrogen in Steel

Due to the significant effects of nitrogen on the mechanical properties of steel, the rapid measurement of nitrogen during the manufacturing process is highly desirable. The PDA-7000 has recently been developed to replace gas analyzers for in-furnace analysis. It achieves a lower detectable

limit of 5ppm. This instrument reduces sampling operations and shortens analysis times. Additionally, it eliminates sample defects and enhances yields through its ability to control nitrogen in cast iron.

Sensitive Analysis of Trace Elements in Steel

The establishment of manufacturing technologies for high-purity iron demands process control at lower trace levels of elements, including C, P, and S.

The PDA-7000 meets these needs by permitting quick and easy ppm-level analysis by time-resolution PDA photometry.

Elimination of Contamination Effects

Replaceable units in the new spark stand eliminate to the maximum degree effects from high-content sample analysis during trace-element analysis.

This effectively eliminates effects from the analysis of aluminum alloys when high-purity aluminum is analyzed, for example.

New Spark Stand Enhances Stability

The structure and materials of the conventional spark stand have been upgraded to considerably enhance analysis accuracy for high-concentration elements (stainless steel and aluminum alloy). It accepts large sample plates, offers greater ease of handling, and enhances durability. Further, selecting the optional stand water-cooling kit (see page 12) restricts the spark stand temperature rise due to electrical discharge during continuous analysis, thereby enhancing the stability of the measured values.



Spark Stand

Electrode Cleaning Extends Electrode Life approx. 10 Times

Electrode life is increased by approximately ten times by adopting brushing for electrode regeneration in addition to conventional reversed discharge. Naturally, the convenient reversed discharge is also provided as standard.

To enhance long-term stability, the optional automatic

electrode-cleaning unit (page 12) can be selected to keep the counter electrode clean by automatically brushing away adhering sample deposits. The attached automatic sample retainer mechanism allows everyone to set samples under identical conditions.

New Chassis Case Design offers Superb Environmental Resistance

The newly designed chassis case enhances environmental resistance.

The monochromator is made of materials resistant to the effects of temperature fluctuations and is installed in a constant-temperature chamber.

The popular compact design is retained. The chassis case can be

mounted against the wall to save space. The functional design allows maintenance access from the front.

The chassis case design offers greater freedom in analysis laboratory layout.

Vacuum Monochromator

The monochromator must be held in a vacuum or in a gas-replacement atmosphere to avoid effects due to the absorption of spectral lines such as C, P, S, B, and N by atmospheric oxygen.

Shimadzu adopts a vacuum monochromator that is resistant to the effects of temperature fluctuations. It is installed in a temperature-controlled monochromator chamber to achieve extremely stable measurements.

Select Optimal Discharge Conditions to Suit Analysis Range and Elements

Several separate discharge types are available for each analyzed element: high-energy discharge, spark discharge for excellent reproducibility, and arc-like spark discharge for high sensitivity. A combination of these can also be selected to set the optimal discharge conditions.

Used with time-resolution photometry, these settings achieve high analysis accuracy.

The addition of the optional small-sample analysis kit (page 12) permits measurements on 0.01mm-thick samples and small-diameter samples.

User-friendly Software

The software was designed for process analysis, with due consideration of the situation at sites where metals analysis is conducted in Japan. After the instrument is started, only one action is required to enable measurement and allow simple

process analysis.

Simply enter the required information in sequence to easily create the analysis information.

Extremely Simple Operation

Simply mount a sample in the spark stand, enter the sample number, and press the start button to display the analysis results on the screen in just over ten seconds. (The actual analysis time

depends on the analysis conditions.)

The analysis data can be easily converted for flexible processing by commercial software.

Energy-Saving Design to Reduce Running Cost

While the instrument is not in analysis mode, argon gas flow is reduced to one-tenth compared with conventional model.

Energy-saving design contributes lower running cost.

Features of the PDA-7000 Series

Superbly Functional Software Supports Your Operation

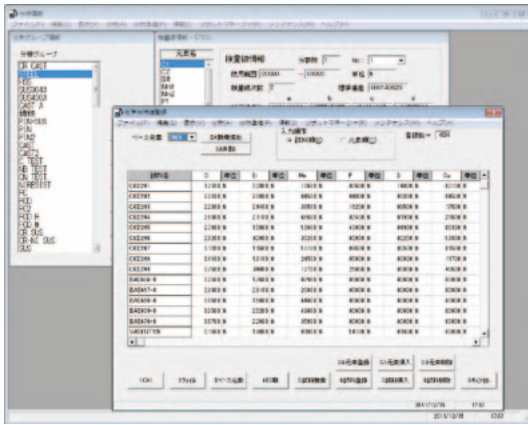

Analysis Information Screen

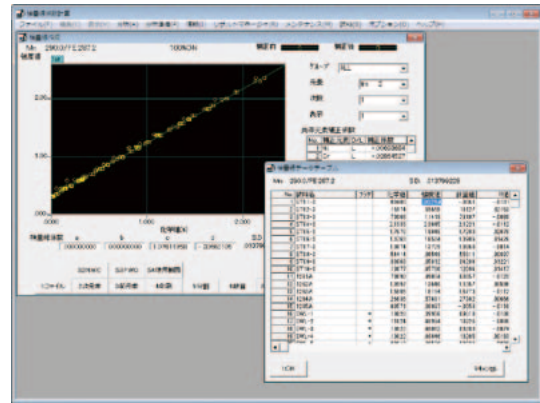

Calibration Curve Screen

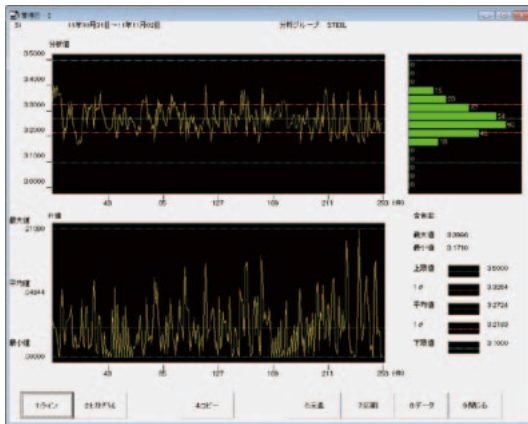

Control Chart

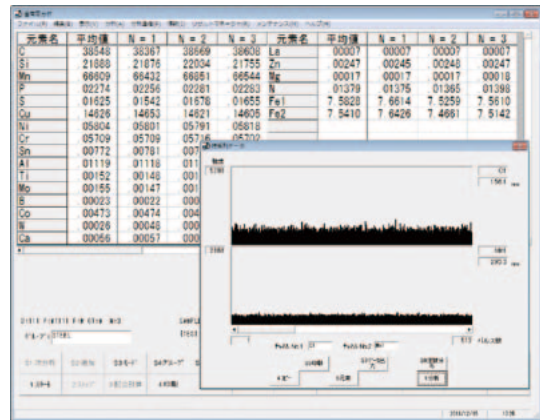

Content Analysis Screen

Analysis data can be transferred to host computers and printer.

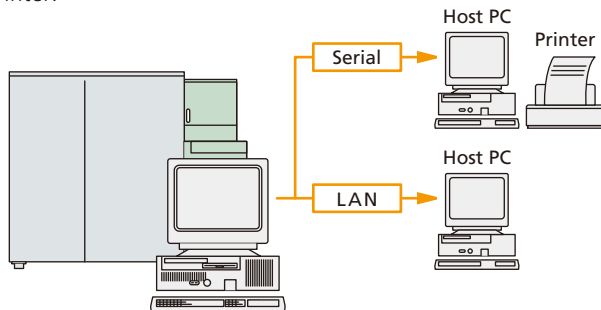

Analysis Information and results can be used in commercial database/spreadsheet software.

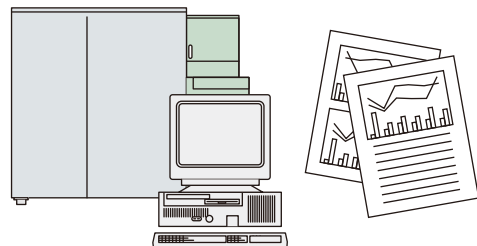

Analysis Applications and Ranges

PDA-7000, Al base fixed channel
 Analysis range example for cast aluminum such as AD and ADC JIS components. Functions restricted to cast aluminum.

PDA-7000, Fe base fixed channel
 Analysis range example for cast iron. (Also handles the analysis of alloy steels with low additive levels.) Functions restricted to cast iron.

Analysis range example of Al base fixed channel

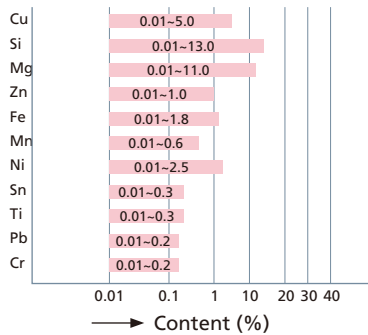

Analysis range example of Fe base fixed channel

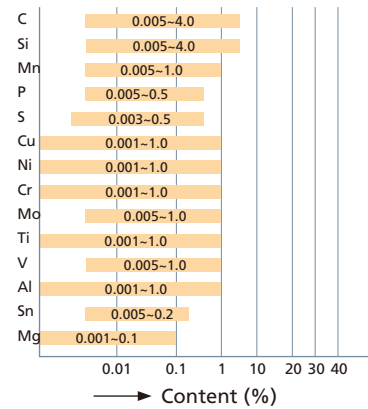

PDA-7000 Analysis range examples

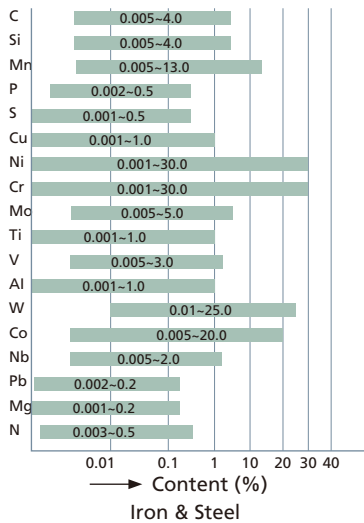

Iron & Steel

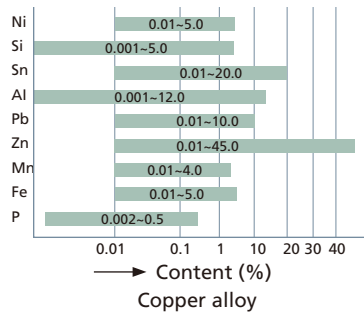

Copper alloy

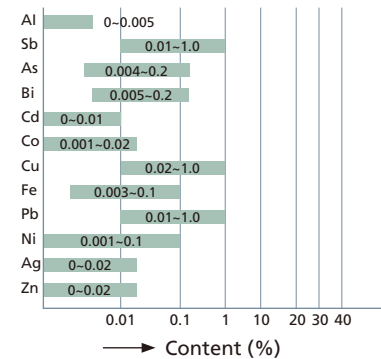

Tin alloy

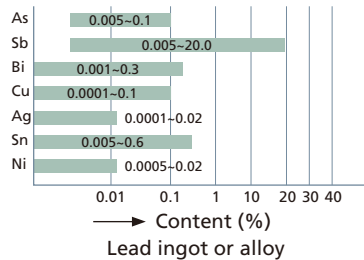

Lead ingot or alloy

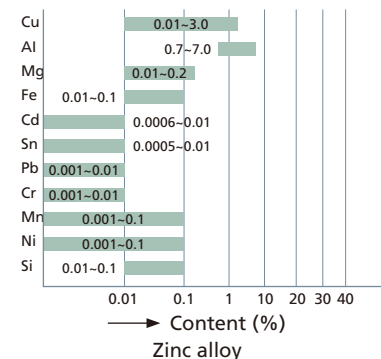

Zinc alloy

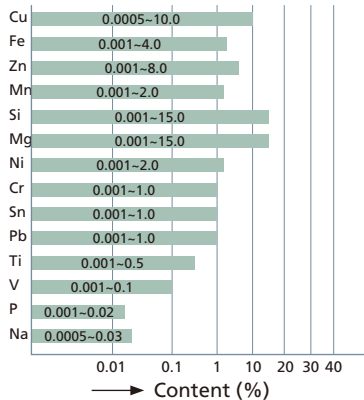

Aluminum ingot or alloy

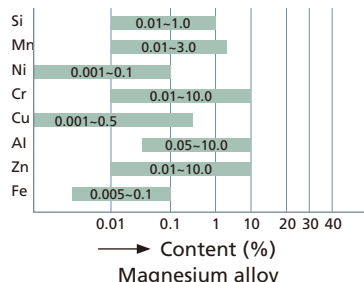

Magnesium alloy

● As the number of light receptors in the PDA-7000 differs according to the purpose of the analysis, consult Shimadzu on the applicable elements and analysis range for each analysis purpose. The percentage content values in the tables indicate the range of content values in normally analyzed samples; they do NOT indicate the analysis range of the instrument. It is possible to analyze elements other than the elements indicated.

PDA Time-resolution Analysis

Shimadzu's unique PDA photometry is installed as standard to offer a variety of benefits for various analyses.

PDA Photometry (Pulse Distribution Analysis Photometry)

Unlike conventional photometry that simply integrates the photocurrent obtained from discharges over a fixed time, the PDA method integrates the photocurrent obtained from each discharge pulse and analyzes each integral value as having an individual significance. The optimal processing is then used to

determine the percentage content.

PDA permits speciation analysis and a variety of data processing not possible with previous methods, which significantly increases the analysis accuracy for many elements.

Time-resolution Analysis (Patented)

The discharge conditions to obtain the optimal measurement sensitivity differ for each spectral line.

The diagram at the right shows the current waveform for typical discharge conditions. Some elements exhibit sensitivity in Area A, others in Area B. Analyzing the elements separately in the individual areas dramatically enhances the sensitivity for trace elements.

The table below compares the Background Equivalent Concentration (BEC) values for a conventional method and the PDA-7000.

The lower the BEC value, the higher the sensitivity for trace elements.

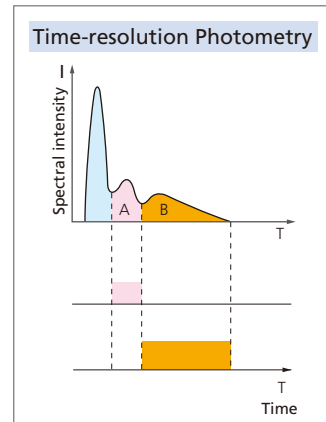

Element	C	P	S	B
Conventional method(ppm)	160	150	100	80
PDA-7000(ppm)	80	75	50	40

Shorter Analysis Times (just over 10 seconds per analysis)

Combined discharge and PDA time-resolution photometry obtain results in just over ten seconds per analysis.

Data is Controllable for each Discharge, Allowing Photometric Values for Abnormal Discharge Pulses to be Eliminated for Enhanced Accuracy

Conventional photometry determines the overall integral value of the light intensities. However, the PDA-7000 Series determines the frequency distribution of the light intensities

and then conducts statistical processing, thereby achieving measurements that are unaffected by light intensities from abnormal discharges.

Enhanced Accuracy for Insoluble Elements that Readily Form Inclusions (Patented)

Achieves two or three times the reproducibility of conventional Shimadzu methods.

conventional method and the PDA-7000 for elements that readily form inclusions.

The table at the right compares reproducibility values for a

Element	Total Al	S	Pb	B	Ca	
Content (%)	0.037	0.022	0.005	0.0035	0.002	
Reproducibility σ (%)	Conventional method	0.0025	0.0010	0.0010	0.00027	0.00045
	PDA-7000	0.00045	0.0004	0.0002	0.00005	0.0001

Reduced Effects of Sample Defects (cracks, pinholes) on Analysis Values (Patented)

The internal standard monitoring method is applied to each discharge pulse to monitor the light intensity for internal standard elements. If this value lies within the specified range, the light intensities obtained for the measured elements are selected.

To enhance reproducibility, statistical processing is used to eliminate the data obtained when the spark is applied to a defect resulting from sampling.

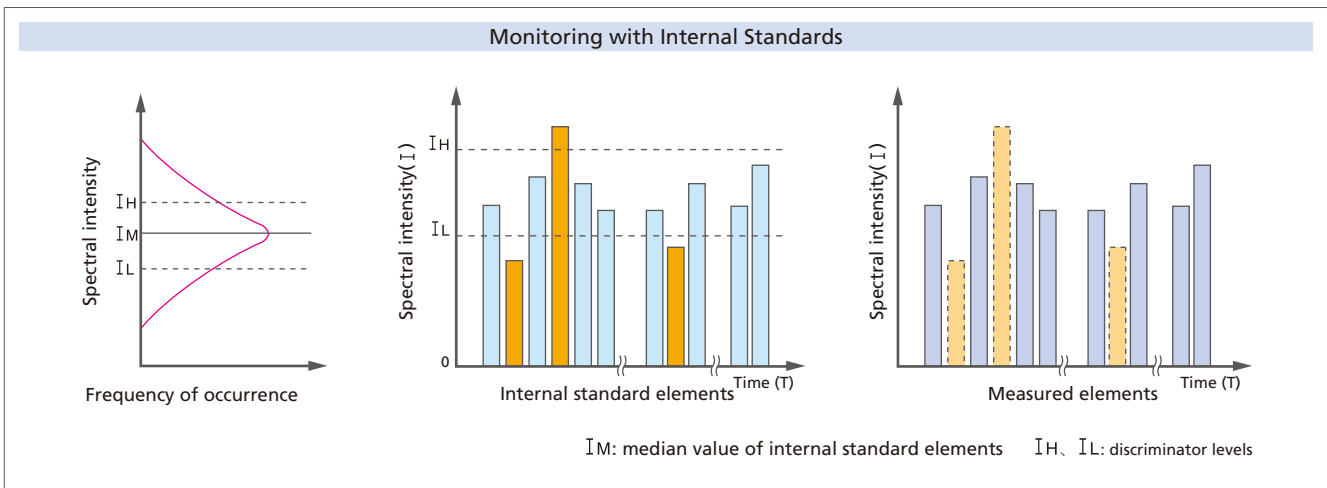
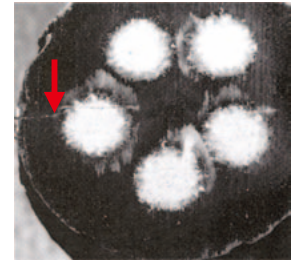

Acid-soluble Speciation Analysis (Quantitation of Acid-soluble Aluminum)

Statistical processing based on the differences in light intensity between acid-soluble aluminum (sol-Al) and acid-insoluble aluminum (insol-Al) allows quantitation of acid-soluble aluminum in just 1 seconds.

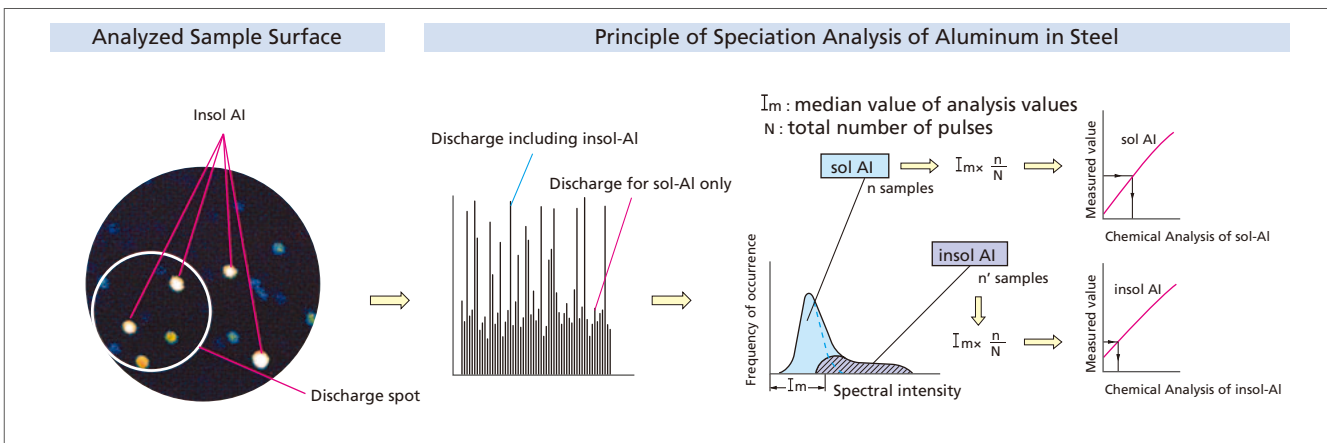

Principle of Optical Emission Spectrometry

In optical emission spectrometry, electrical energy is imparted to a metal sample and the vaporized atoms are excited to obtain emission spectra unique to the elements. These emission spectra are separated by a monochromator and a detector (photomultiplier tube) detects the presence and intensity of each for quantification and qualification of the elements contained in the sample. This analysis method requires no complex pretreatment and obtains quantitative

values for several tens of elements within one minute of starting analysis. Shimadzu optical emission spectrometers use a unique process to obtain analysis results in just over ten seconds after starting analysis. Optical emission spectrometers using photoelectric photometry are prescribed in the Japan Industry Standards (JIS) and are adopted for a wide range of official analyses.

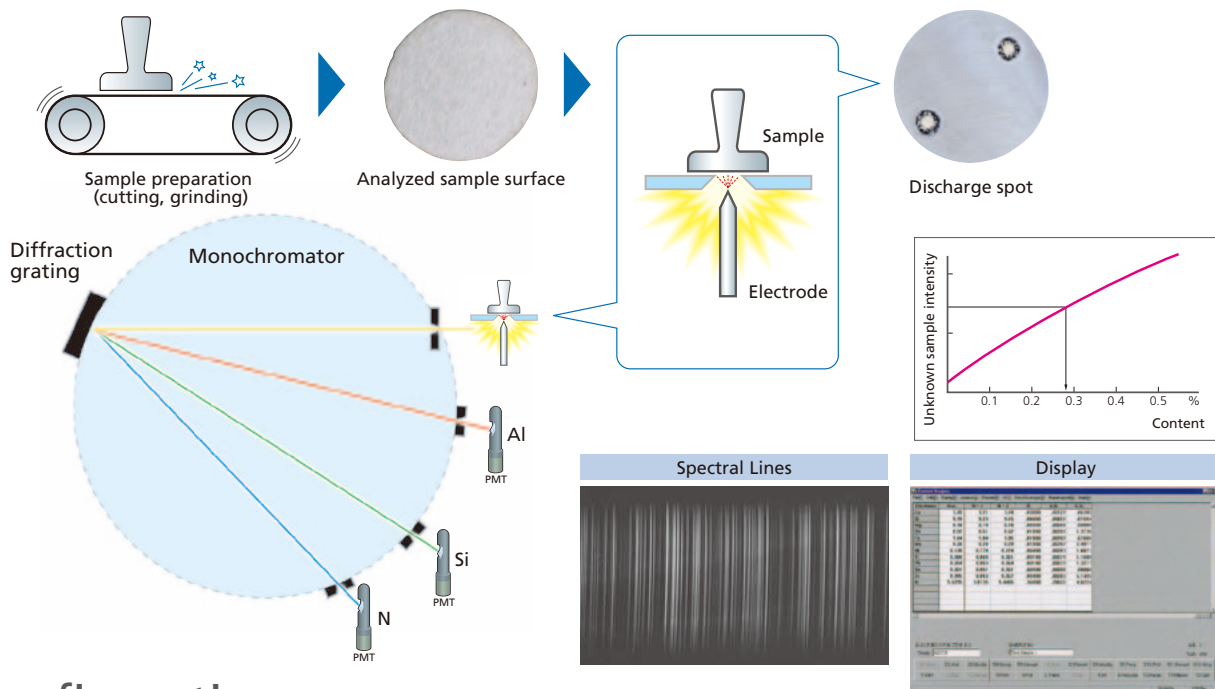

Configuration

The PDA-7000 comprises the following parts:

- Excitation unit** The spark stand generates sparks between the sample and the counter electrode. Emission spectra of the elements in the sample are introduced into the monochromator unit.
- Monochromator unit** Splits the light into emission spectral lines. A sensor converts this light into electric currents.
- Readout unit** Measures the generated photocurrents.
- Data processing unit** Analyzes and processes the measured data.

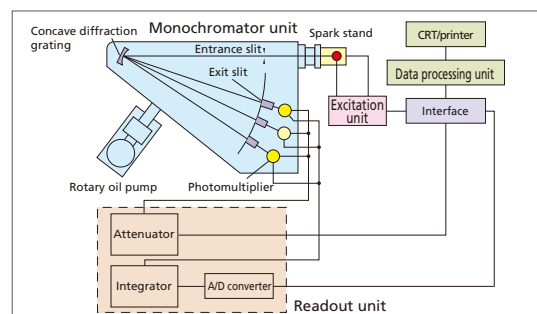
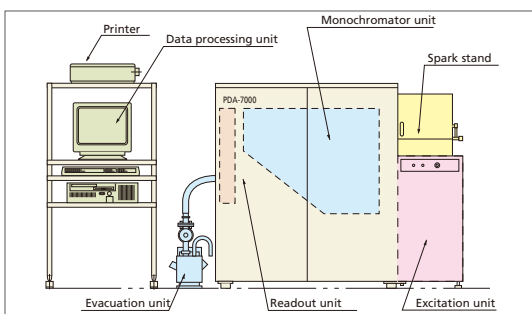

Applications of Optical Emission Spectrometry

The Optical Emission Spectrometer covers a wide analysis range from trace levels to high concentrations of metals – including steel, aluminum, magnesium, copper, zinc, lead, tin, titanium, nickel, and cobalt – in ingots or alloy

components.

It is used for process-control analysis and for raw materials delivery and product dispatch inspections in the metals refining and processing industries.

Ferrous Applications



Steel

- Quality control by rapid in-furnace analysis at each stage of manufacture
- Analysis for product standards evaluation
- Materials deliver inspections



Cast Iron

- Quality control by rapid in-furnace analysis at each stage of manufacture
- Analysis for product standards evaluation
- Materials deliver inspections

Non-ferrous Applications



Aluminum Ingot and Rolling Industries

- Quality control by rapid in-furnace analysis at each stage of manufacture
- Analysis for product standards evaluation
- Materials deliver inspections



Other Metals

- Quality control by rapid in-furnace analysis at each stage of manufacture
- Analysis for product standards evaluation
- Materials deliver inspections

Machinery, Automobile, and Ship-building Applications

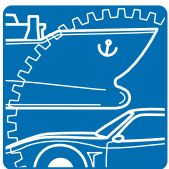

- Analysis for product standards evaluation
- Materials deliver inspections



PDA-7000 Series
Optical Emission Spectrometer

Options

Extensive options are available to handle a variety of analyses.

Electrode-cleaning Unit

To enhance long-term stability, the optional electrode-cleaning unit keeps the counter electrode clean by brushing away adhering sample deposits. The attached sample retainer mechanism allows anyone to set samples under identical conditions.

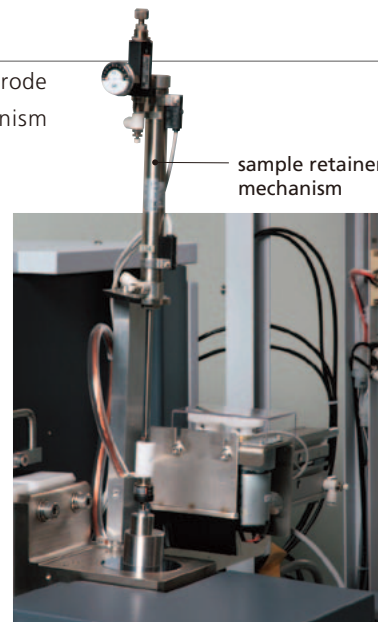
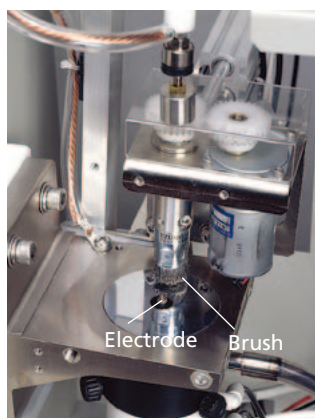

Sample cleaning unit

Stand Water-cooling Kit (P/N: 211-74666-92)

Enhances the stability of the measured values by restricting the spark stand temperature rise due to electrical discharge during continuous analysis.

Small-sample Analysis Kit (P/N: 211-74665-**)

Handles samples between 3 mm and 12 mm in diameter.

Sample diameter	3mmø, or more	P/N S211-74665-93
	4mmø, or more	P/N S211-74665-96
	5mmø, or more	P/N S211-74665-94
	6mmø, or more	P/N S211-74665-95
	7mmø, or more	P/N S211-74665-91
	8mmø, or more	P/N S211-74665-97
	9mmø, or more	P/N S211-74665-92

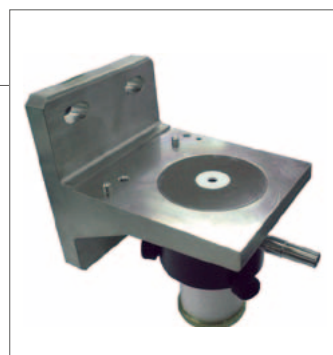

Pin Sample Holder (P/N: 211-74594)

Handles wire and bolt samples between 0.6 mm and 12 mm in diameter.

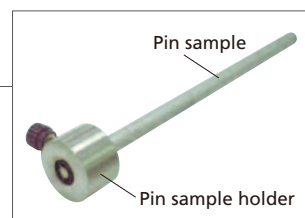

Factory Calibration (FC)

Internal calibration curves (Note 1)

Type	Steel : 10 types	FC Low-alloy steel	211-53955-01
		FC Austenitic stainless steels	211-53955-02
		FC Ferrite stainless steels	211-53955-03
		FC Low-alloy cast iron	211-53955-04
		FC Free-cutting steels	211-53955-05
		FC High-manganese steels	211-53955-06
		FC High-speed tool steels	211-53955-07
		FC High-alloy cast iron	211-53955-08
		FC Ni-resist cast iron	211-53955-09
		GC Steel	(Note 2)

Note 1: Must be ordered with the instrument.

Note 2: The following two items are required for GC steel:
 1. Global Calibration (GC), steel (P/N: 211-53953)
 2. 31 for global standardization (P/N: 210-00004-31)

Type	Aluminum alloy : 6 types	Low-alloy Al	Al – Cu
		Al – Si	Al – Zn
		Al – Si – Cu	Al – Mg

Type	Copper alloy : 8 types	FC Bronze	211-53956-01
		FC Gun Metal	211-53956-02
		FC Aluminum Bronze	211-53956-03
		FC Brass	211-53956-04
		FC Silicon Brass	211-53956-05
		FC Pure Copper	211-53956-06
		FC Nickel Silver	211-53956-07
		FC Capro Nickel	211-53956-08

Consult your Shimadzu representative about other metals.

Options

Options for Sample Preparation

1. Sampling Mold and Surface Plate

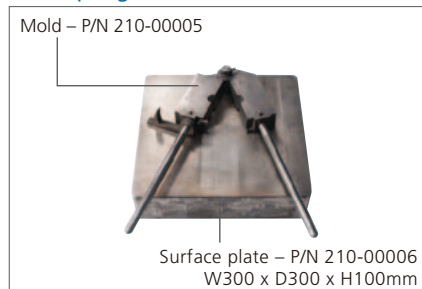

2. FS-3N Belt Grinder

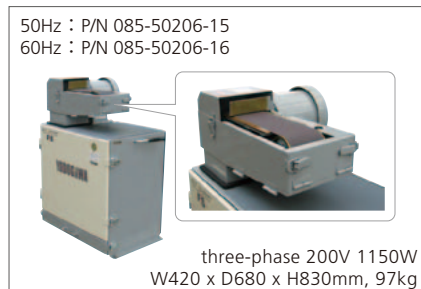

3. L-1000 MM-02 Bench Lathe

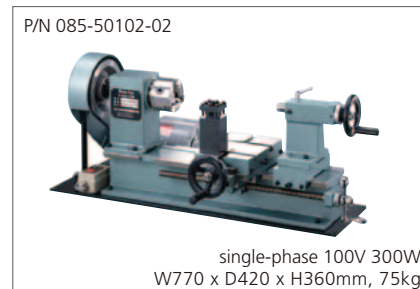

Items 1) and 2) below must be ordered with the bench lathe.

- 1) O.D. holder (Tip holder) P/N 085-50102-12
TCGCR/L1010F-08
- 2) Tip (for non-ferrous samples) P/N 085-50102-13
TCGT080202FRL-U KW10
- 3) Bench lathe stand E-17 P/N 085-50102-11
Size: W1200 x D600 x H740mm

Consumables

1. Tungsten electrode P/N 211-74362
2. Brush P/N 211-74965
3. Pump oil, 1 liter P/N 017-30159-03

Tungsten electrode



4. MT-11M Polishing Machine (for 6 mm dia. tungsten electrodes)



Standard Samples for Analysis

Contact your Shimadzu representative for information on the selection and preparation of standard samples for each analysis purpose. Also consult Shimadzu if chemical analysis is required.

■ Cast Aluminum Standard Samples

Cast aluminum standard samples for standardization (disk type), set of 5 (P/N 080-94801-21)
Standard accessory with PDA-7000, Al base fixed channel.

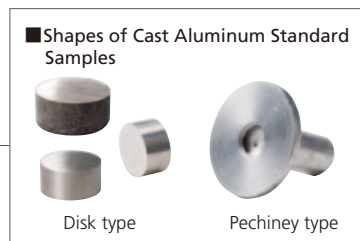

■ Cast Iron Standard Samples

These standard samples are created using Shimadzu's many years of research and experience. They are white pig iron samples of alloy cast iron and normal cast iron, offering highly reliable carbon analysis and an adequate concentration range of component elements for optical emission spectrometry.

- Cast iron standard sample for standardization (disk type), set of 3 (P/N 211-72591-92)
One set of 3 supplied as standard accessory with PDA-7000, Fe base fixed channel.
- No. 21 Cast iron standard sample for calibration curves (mushroom type), set of 10 (P/N 210-00004-21)

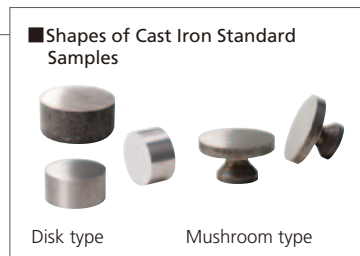

■ Low-alloy Steel Standard Samples

These standard samples contain many component elements in concentration ranges found in actual low-alloy steels. The concentrations are strictly controlled to ensure high reliability.

- No. 14 Low-alloy steel standard sample for standardization (disk type), set of 3 (P/N 239-00100)
Supplied as standard accessory with PDA-7000, Fe base fixed channel.
- No. 5 Low-alloy steel standard sample for calibration curves (disk type), set of 10 (P/N 210-00004-05)



Major Specifications

Monochromator unit

Dispersion system	Paschen-Runge mounting for concave diffraction grating
Diffraction grating	Concave radius of curvature: 600 mm Number of grooves: 2400 grooves/mm Reciprocal dispersion: 0.69 nm/mm
Wavelength range	121 to 481 nm and 589 nm
Evacuation system	Direct-linked rotary pump. Ultimate pressure: 2 Pa

Excitation Unit

Discharge voltage	500 V or 300 V, selectable
Discharge frequency	One of three frequencies automatically set for the discharge conditions. 500 Hz max.
Voltage accuracy	Main voltage $\pm 1\%$ However, input voltage coefficient of variation within $\pm 10\%$
Discharge conditions	6 types
Counter electrode cleaning	Automatic regeneration by reversing electrode polarity after each analysis
Spark stand	Stand for argon atmosphere

Readout unit

Number of light receptors (channels)	64 channels max.
Method of measurement	Single-pulse integration method Time-resolution PDA photometry

Data Processing Unit

Windows Kit (P/N 211-19209-98)

Mainly adds the following functions:

1. Report functions Database functions	Uses ACCESS for analysis results ACCESS is a registered Trademark of Microsoft Corporation.
2. Maintenance Instrument management functions	Counter electrode replacement, stand cleaning Management of inlet slit position according to number of discharges Management of pump oil replacement and igniter cleaning periods

Installation and Optional Accessories

Installed Environment

Area Approx. 3 x 2 m min.

Temperature Approx. 10°C to 28°C

Humidity 70% RH max.

Note Heat generation approx. 1100 kcal/hour

The instrument highly resistant to dust and other environmental factors.

However, avoid installing the data processing unit in an environment subject to vibrations, dust, and strong electrical fields.

Power Supply

- 200, 220, 230, or 240 V $\pm 10\%$, single-phase, 50/60 Hz, 4.0 kVA
- Ground: Individually grounded 30 W max. Provide near the rear of the instrument.

Gas

Argon gas : A central supply with switching between at least two cylinders is convenient.

Argon gas purity 99.999% min.

Dew point below -70°C .

Optional Accessories (Require separate installation locations and power supplies.)

- Sampling Mold and Surface Plate
- L-1000 MM-02 Bench Lathe: single-phase 100V 300W
- FS-3N Belt Grinder: three-phase 200V 1150W
- MT-11M Polishing Machine: single-phase 100V 110W
- * See the Installation Guide for details.

External Dimensions and Weight

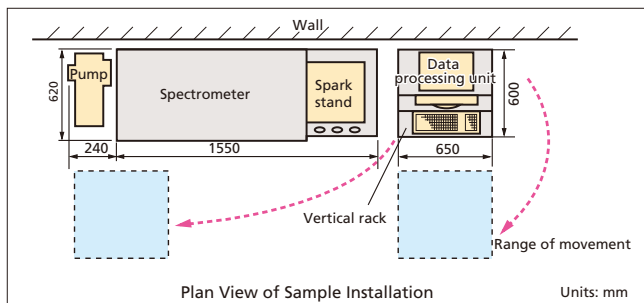

PDA instrument 1550 (W) x 620 (D) x 1330 (H) mm

Rotary oil pump 230 (W) x 475 (D) x 253 (H) mm

Data processing unit 650 (W) x 600 (D) x 1380 (H) mm
(When installed on PC rack.)

Weight (system) Approx. 500 kg total

Note: The instrument can be mounted against the wall to save space.

Maintenance can be conducted from the front.

The data processing unit can be moved near to the operated instrument.

Take due care of locations where this warning label is attached.

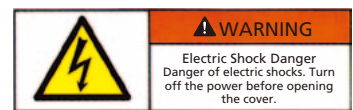



Shimadzu Corporation
www.shimadzu.com/an/

Company names, product/service names and logos used in this publication are trademarks and trade names of Shimadzu Corporation or its affiliates, whether or not they are used with trademark symbol "TM" or "®".
Third-party trademarks and trade names may be used in this publication to refer to either the entities or their products/services. Shimadzu disclaims any proprietary interest in trademarks and trade names other than its own.

For Research Use Only. Not for use in diagnostic procedures.
The contents of this publication are provided to you "as is" without warranty of any kind, and are subject to change without notice. Shimadzu does not assume any responsibility or liability for any damage, whether direct or indirect, relating to the use of this publication.