

Liquid Chromatograph Mass Spectrometer

# LCMS-8050

**UFMS**  
ULTRA FAST MASS SPECTROMETRY



Speed and



# Sensitivity Beyond Comparison

---

Continuing the evolution of Shimadzu's UF technology, Shimadzu introduces the LCMS-8050 triple quadrupole mass spectrometer, offering unparalleled measurement speeds and high-sensitivity performance.

High-sensitivity quantitation delivered at high speed

Multi-component analysis performed more rapidly

Simultaneous qualitative and quantitative analyses

The high performance of the LCMS-8050 defies expectations, redefining high-sensitivity, high-speed analysis.



# Experience a New Realm of High-Sensitivity & High-Speed Performance



UfSensitivity  
Combining Speed and High Sensitivity

## Ufswitching ■ High-Sensitivity & High-Speed Positive/Negative Ionization Switching in 5 msec

### Just One Minute per Analysis A Case Study Using High-Speed Positive/Negative Ionization Switching

When performing simultaneous positive/negative ion measurements of multiple components, the proper acquisition of sharp UHPLC peaks depends on rapid polarity switching. The LCMS-8050 minimizes losses due to polarity switching and ensures the collection of sufficient data points for even the narrow peaks obtained with UHPLC, recording accurate peak shapes and allowing excellent reproducibility.

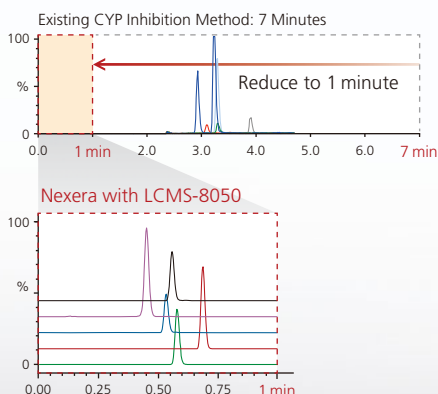

- Easily obtains over 20 points per peak with UHPLC.
- Achieves excellent reproducibility even at the lowest calibration level.
- Features a wider dynamic range than other available triple quads.

Compound	Polarity	Legacy HPLC Method 7 min			Nexera with LCMS-8050 1 min		
		Dynamic range (nmol/L)	Points/peak	%RSD 0.6 nmol/L (n=4)	Dynamic range (nmol/L)	Points/peak	%RSD 0.6 nmol/L (n=4)
Resorufin	+	0.6-300	19	4.66	0.6-1000	21	4.30
1'-Hydroxy Bufuralol	+	0.6-300	21	2.39	0.6-1000	24	1.82
(+/-)-4'-Hydroxy Mephenytoin	+	0.6-300	20	2.75	0.6-1000	23	2.18
Oxidized Nifedipine	+	0.6-300	19	5.58	0.6-1000	23	5.07
Hydroxy Tolbutamide	-	0.6-300	20	5.68	0.6-1000	23	2.96

# UFscanning ■ High-Sensitivity & High-Speed Scanning at 30,000 u/sec

## Simultaneous Quantitative and Qualitative Analysis Simultaneous High-Speed Screening of 12 Toxicological Drugs

The LCMS-8050 is capable of simultaneously obtaining both qualitative and quantitative information in a single analysis. Acquisition occurs so rapidly that MS/MS scans and MRM measurements can be performed concurrently while maintaining quantitative accuracy. MS/MS scans are usable and reliable because even at 30,000 u/sec, Shimadzu uses a 0.1 u scan step.

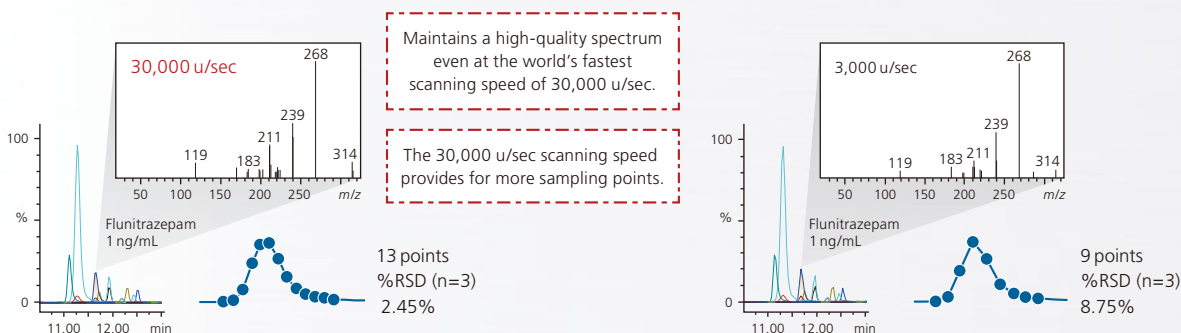

MRM Triggered Product Ion Scanning of a Mixture of 12 Benzodiazepines (1 ng/mL each)

# UF-MRM ■ High-Sensitivity & High-Speed MRM at 555 ch/sec

## Detect Target Compounds at Trace-Level Concentrations Simultaneous Analysis of 29 Pesticides for Water Quality Analysis

The LCMS-8050 is capable of simultaneously acquiring 555 MRM transitions per second while maintaining accuracy and precision. Sufficient data points can be collected for quantitation ions, reference ions, and internal standard ions even in chromatographic regions with unresolved peaks. The high sensitivity of the LCMS-8050 allows for trace-level analysis, such as pesticides in drinking water, without the need for sample pre-concentration. This high sensitivity is maintained even when monitoring numerous MRM channels.

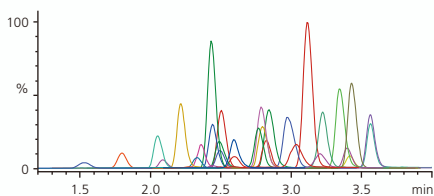

MRM Chromatogram of 29 Pesticides  
for Water Quality Analysis (100 pg/mL each)

LCMS-8050 has achieved LOQs that fulfill the 1/100 target value without sample pre-concentration.

No.	Compound	LOQ pg/mL	1/100 of target pg/mL*	No.	Compound	LOQ pg/mL	1/100 of target pg/mL*
1	Thiuram	2.0	200	16	MPP oxon sulfoxide	4.2	10
2	Bentazone	3.9	2000	17	MPP oxon sulfone	5.7	10
3	Carbofuran	1.6	50	18	Dymron	0.65	8000
4	2,4-D	46.7	300	19	Methomyl	2.3	300
5	Triclopyr	45.3	60	20	Probenazole	5.2	500
6	Iprodione	1.7	3000	21	Diuron (DCMU)	0.7	200
7	Asulam	2.3	2000	22	Bensulfuron-methyl	4.4	4000
8	Bensulide	4.8	1000	23	Tricyclazole	2.7	800
9	Mecoprop (MCPP)	6.1	50	24	Azoxystrobin	2.7	5000
10	Carbaryl (NAC)	2.3	500	25	Halosulfuron-methyl	0.52	3000
11	Carpropamid	1.3	400	26	Flazasulfuron	0.47	300
12	Fenthion (MPP)	3.1	10	27	Thiodicarb	3.4	800
13	MPP sulfoxide	1.7	10	28	Siduron	0.82	3000
14	MPP sulfone	5.1	10	29	Fipronil	4.7	5
15	MPP oxon	4.9	10				

\*Note: Official analytical methods require detection to 1/100th of regulatory targets.



## UFsensitivity™

### High Sensitivity for Trace Quantitative Analysis

Scientists who demand trace-level quantitation will benefit from a newly designed heated ESI probe and a new high-efficiency CID cell, the UFsweeper III. These technological improvements combined with Shimadzu's patented ion optics system deliver durable high-sensitivity performance.



## ■ Heated ESI Probe

In order to improve desolvation efficiency, the newly developed heated ESI probe combines a high-temperature gas with the nebulizer spray, assisting in the desolvation of large droplets and facilitating ionization. This development allows for high-sensitivity analysis of a wide range of target compounds.

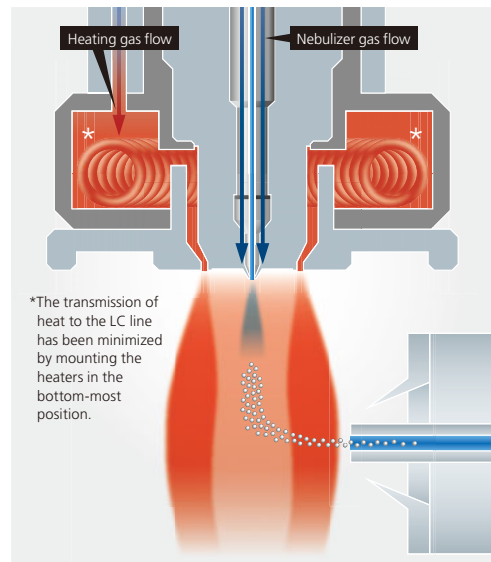
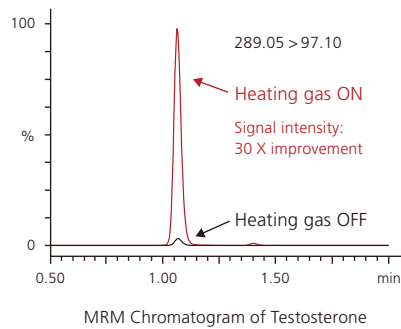

## ■ Excellent Reproducibility Even at Attogram (ag) Levels

Both sensitivity and reproducibility are essential when establishing low limits of quantitation. High-precision quantitative results obtained with the LCMS-8050 in the analysis of Verapamil in blood plasma at levels between 500 ag and 50 pg are shown below. Excellent reproducibility with a % RSD of 2.77 % was obtained when analyzing just 500 ag of Verapamil. The LCMS-8050 demonstrates optimal performance for quantitative analysis of even trace components of a complex matrix.

Concentration actual ng/mL	Calculated concentration ng/mL	% RSD (n = 6)	Accuracy (%) (n = 6)
0.000500	0.000501	2.77	100.2
0.00500	0.00496	3.98	99.2
0.0500	0.0506	1.21	101.2
0.500	0.493	1.31	98.6
5.00	4.89	1.81	97.8
50.0	51.6	0.65	103.2

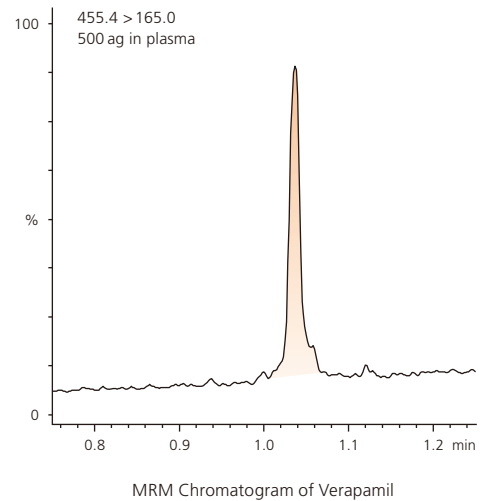



## UFswitching™

---

### Polarity Switching Technology with No Compromise in Quality or Sensitivity

Ultra-high speed positive/negative ionization switching technology [UFswitching] maintains constant quality and sensitivity with no loss of quantitative accuracy. Laboratories can now use a single method for both positive and negative ions, increasing sample throughput and saving method development time.





### ■ Only 5 msec to Achieve Stable Quantitative Accuracy with Positive/Negative Ionization Switching

The LCMS-8050 uses unique high-voltage power supply technology to achieve an ultra-high-speed positive/negative ionization switching time of just 5 msec. The LCMS-8050 is also the only instrument of its type to maintain ion intensity even when performing polarity switching at ultra-high speed, yielding consistent, reproducible data. Excellent quantitative results can be obtained from UHPLC peaks no more than 2-3 seconds wide, even when multiple components are eluted simultaneously.

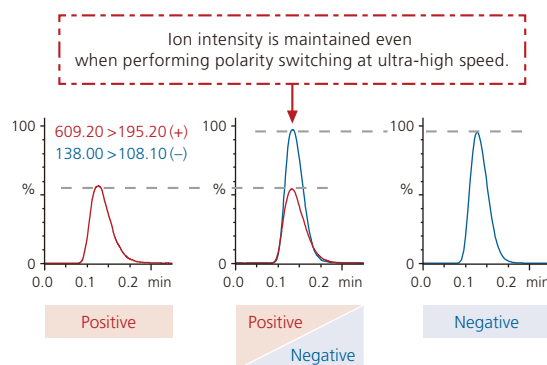

Comparison of measurement using the ultra-fast polarity switching (5 msec) and individual measurement of positive and negative ions.

### ■ Outstanding Throughput and Quantitative Accuracy

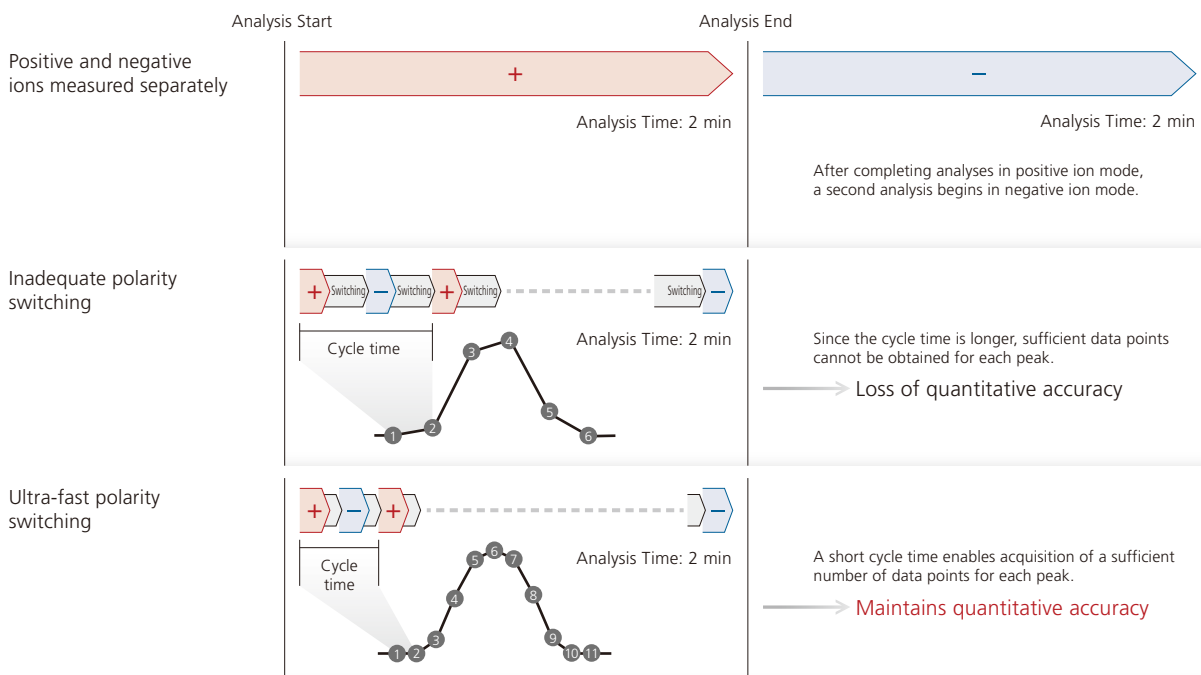

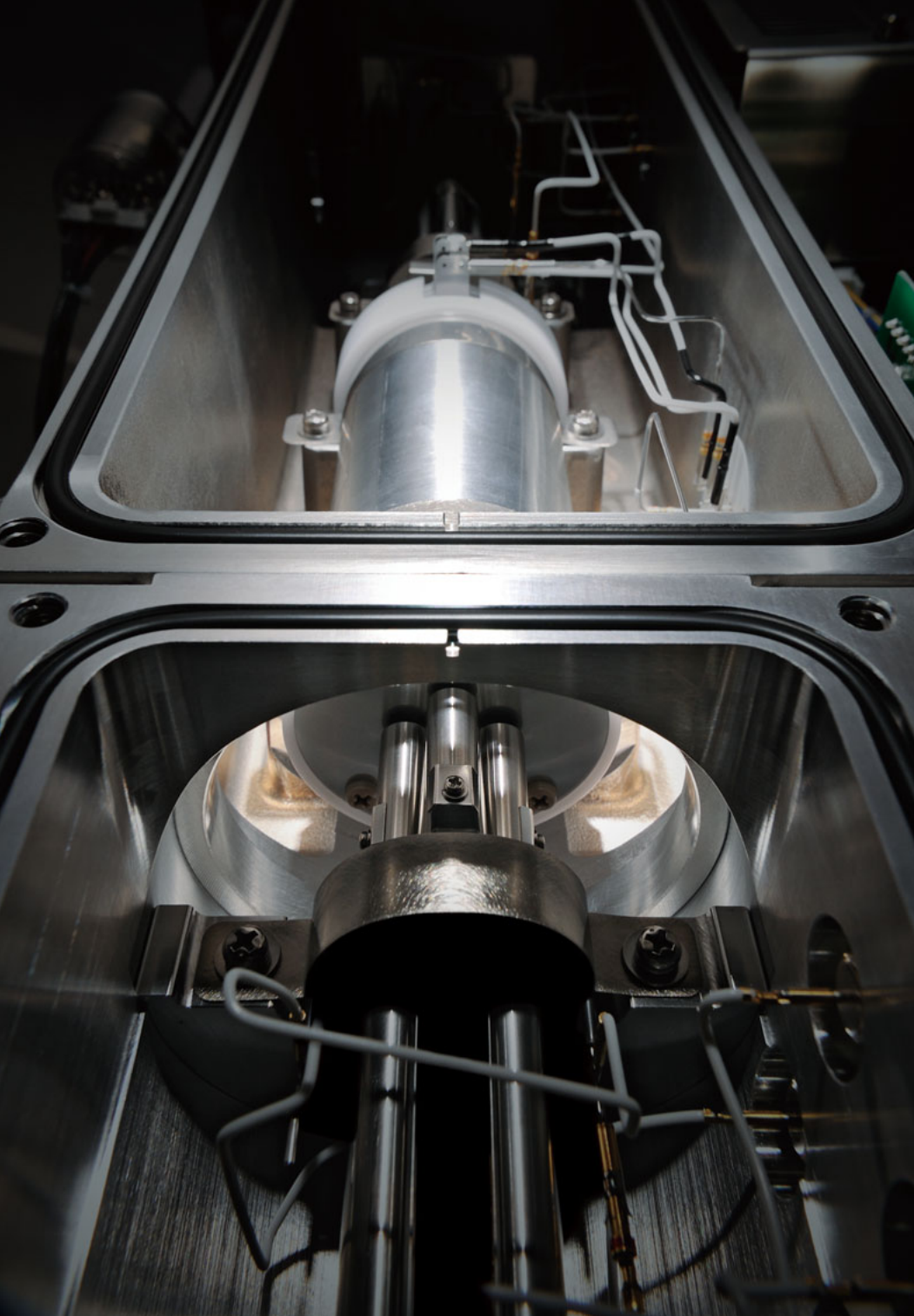

## UFscanning™

---

### Simultaneous, Highly Reliable Quantitative and Qualitative Analysis

Employing ultra-high-speed scan technology [UFscanning], the LCMS-8050 maintains spectrum quality at any scan speed. Perform quantitative and qualitative analysis simultaneously with a high-speed scan rate of 30,000 u/sec.

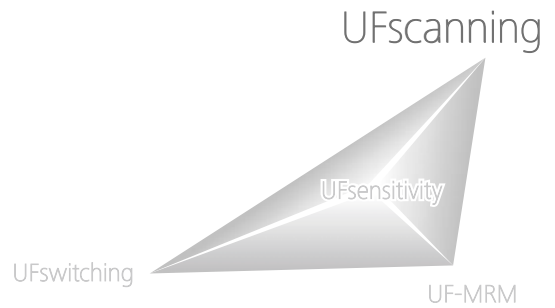

## ■ Maintain Sensitivity and Mass Accuracy Even at 30,000 u/sec

By controlling the voltage applied to the quadrupoles according to scan speed and  $m/z$ , the LCMS-8050 achieves superior ion transmission at any scan speed. And because Shimadzu maintains data collection at 0.1 u intervals, high-quality mass spectra are obtained without loss of sensitivity or mass accuracy.

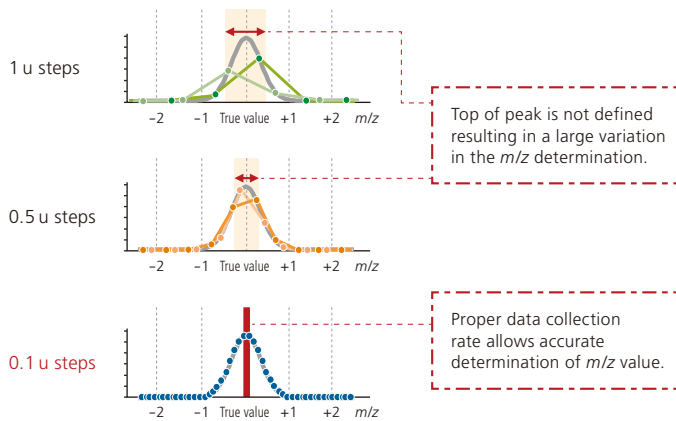

Variation in  $m/z$  Caused by Different Sampling Intervals for Spectral Data

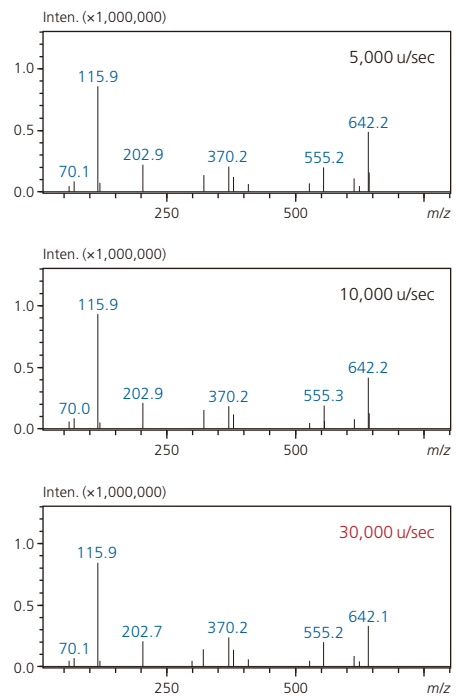

Bradykinin (MW 756.4) Product Ion Scan Spectrum  
Precursor Ion  $m/z$  379.4

## ■ Efficient Qualitative Analysis Using Synchronized Survey Scan

The Synchronized Survey Scan (SSS) function allows MRM acquisition to be combined with a variety of other scan modes. It is extremely useful for obtaining more detailed qualitative information on components detected during multi-analyte quantitative acquisition.

One thousand events can be registered within a single method. It allows setting of optimum collision energies for each component in order to obtain only the required qualitative information.

Type	Event#	+/-	Compound Name	$m/z$	Time (6.647 min - 14.137 min)
MRM	1	+	zolpidem M-1	338.15>265.10	
[- Product Ion Scan	2	+	zolpidem M-1	100.00 > 50.00/340.00	
MRM	3	+	7-aminoflunitrazepam	282.10>121.05	
[- Product Ion Scan	4	+	7-aminoflunitrazepam	100.00 > 50.00/260.00	
MRM	5	+	7-aminoclonazepam	286.08>121.20	
[- Product Ion Scan	6	+	7-aminoclonazepam	100.00 > 50.00/290.00	
MRM	7	+	N-desmethylzopiclone	325.20>245.10	
[- Product Ion Scan	8	+	N-desmethylzopiclone	100.00 > 50.00/380.00	
MRM	9	+	7-aminoflunitrazepam	284.10>135.10	
[- Product Ion Scan	10	+	7-aminoflunitrazepam	100.00 > 50.00/290.00	

An Example Method for Performing an MRM-Triggered Product Ion Scan

## UF Technologies Combine Sensitivity and High Speed

The LCMS-8050 combines the following technologies to ensure highly sensitive, high-speed performance:

[UFsensitivity] achieves high-sensitivity performance utilizing a new heated ESI probe and new UFsweeper III collision cell.

[UFswitching] high-speed positive/negative ionization switching and high-speed MRM [UF-MRM] maintain data quality and sensitivity.

[UFscanning] high-speed scan rate obtains high-quality mass spectra, even during high-speed analysis.

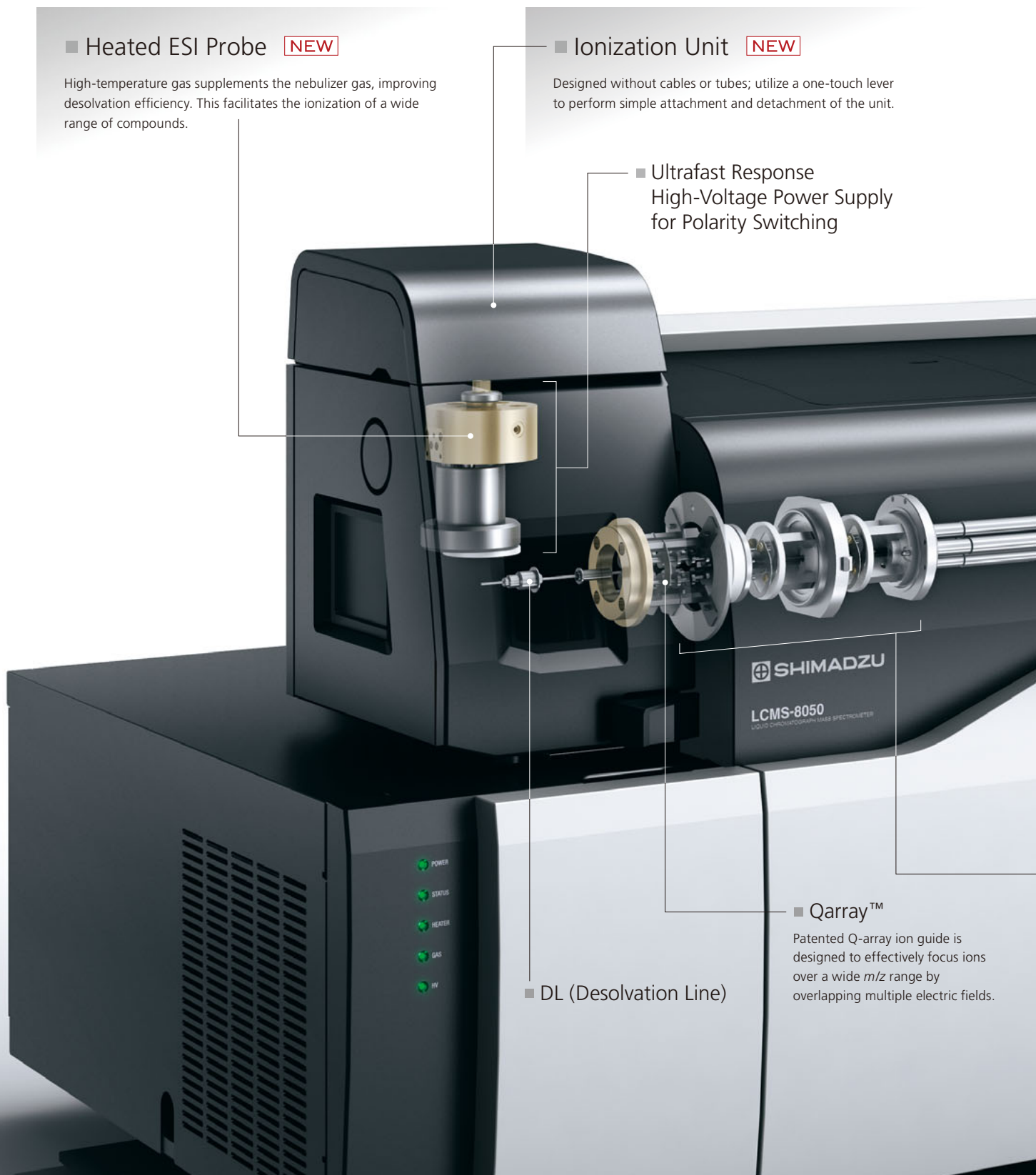

### ■ Heated ESI Probe **NEW**

High-temperature gas supplements the nebulizer gas, improving desolvation efficiency. This facilitates the ionization of a wide range of compounds.

### ■ Ionization Unit **NEW**

Designed without cables or tubes; utilize a one-touch lever to perform simple attachment and detachment of the unit.

### ■ Ultrafast Response High-Voltage Power Supply for Polarity Switching

### ■ Qarray™

Patented Q-array ion guide is designed to effectively focus ions over a wide  $m/z$  range by overlapping multiple electric fields.

### ■ DL (Desolvation Line)

■ UFsweeper™ III Collision Cell **NEW**

A high-sensitivity, high-speed collision cell, the proprietary UFsweeper III accelerates ions out of the collision cell without loss of momentum. Achieving fast sweeping on successive scans, it offers twice the CID efficiency of UFsweeper II, maintains signal intensity, and suppresses crosstalk, even for high-speed or simultaneous multi-component analysis.

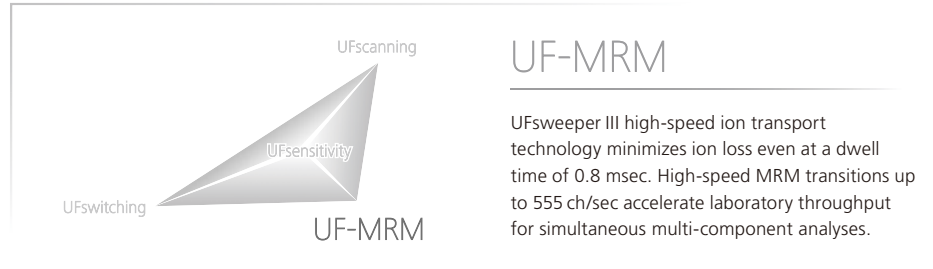
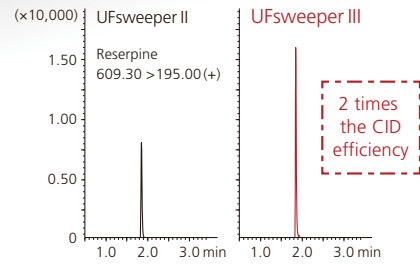

UF-MRM

UFsweeper III high-speed ion transport technology minimizes ion loss even at a dwell time of 0.8 msec. High-speed MRM transitions up to 555 ch/sec accelerate laboratory throughput for simultaneous multi-component analyses.

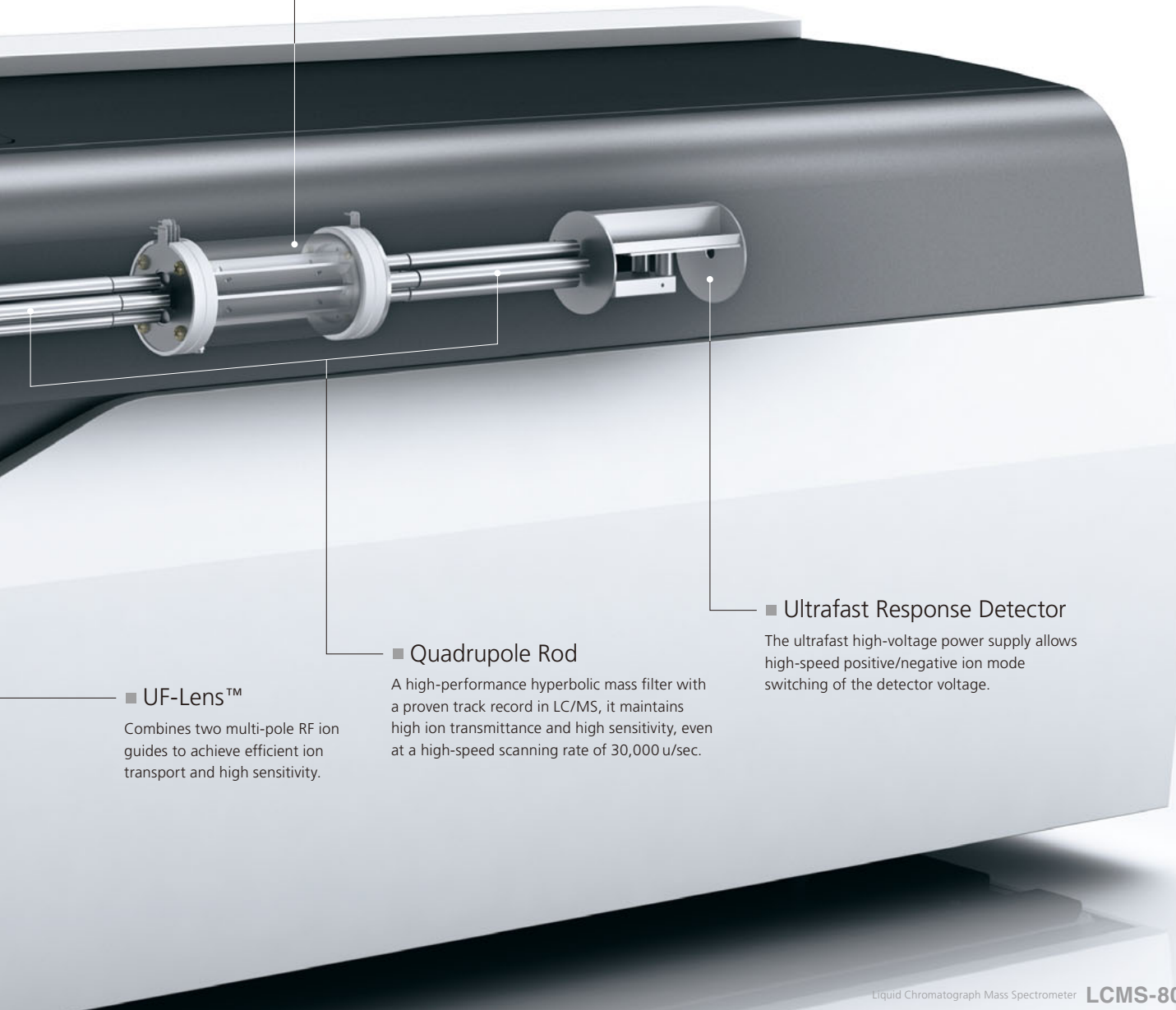

■ UF-Lens™

Combines two multi-pole RF ion guides to achieve efficient ion transport and high sensitivity.

■ Quadrupole Rod

A high-performance hyperbolic mass filter with a proven track record in LC/MS, it maintains high ion transmittance and high sensitivity, even at a high-speed scanning rate of 30,000 u/sec.

■ Ultrafast Response Detector

The ultrafast high-voltage power supply allows high-speed positive/negative ion mode switching of the detector voltage.

# Engineered for Robustness and Easy Operation/Maintenance

## ■ Maintains High Sensitivity Even During Successive Demanding Analyses

In addition to speed and sensitivity, Shimadzu designed the LCMS-8050 for robustness to meet the most demanding laboratory requirements and most difficult matrices. The figure below plots the area results from 1000 consecutive analyses of a deproteinized blood plasma sample spiked with alprazolam. The LCMS-8050 achieves excellent reproducibility with a 4.59 % RSD for the area results over the 1000 analyses.

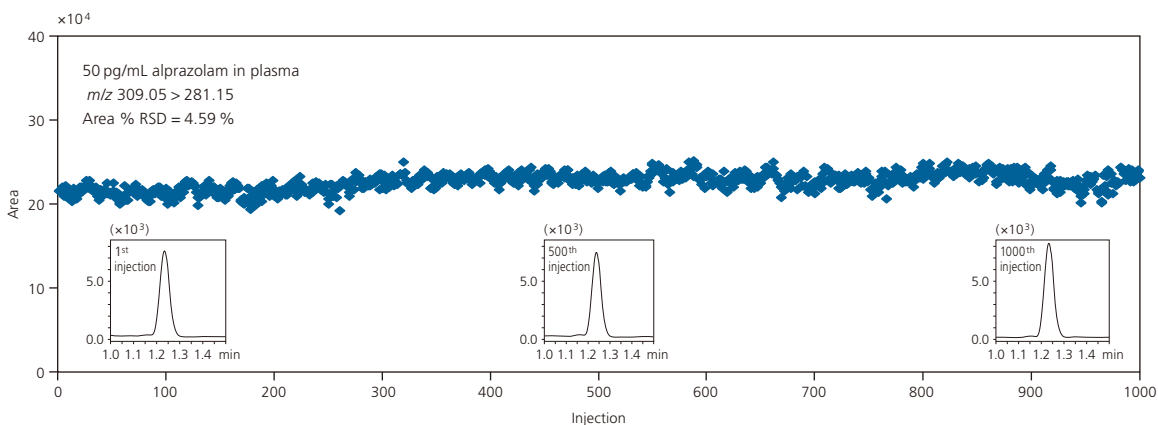

## ■ Easy System Maintenance Reduces Downtime

As with Shimadzu's other triple quad systems, maintaining the LCMS-8050 is simple. Replacing the desolvation line (DL) and ESI capillary is quick and easy. Additionally, the design allows users to replace the DL without breaking vacuum, providing greater uptime and usability.

### ● Steps for DL Replacement

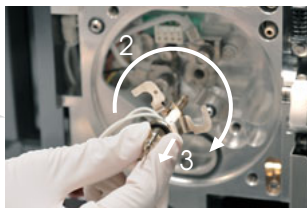
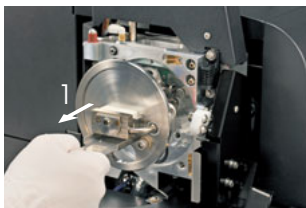

### ● Steps for ESI Capillary Replacement

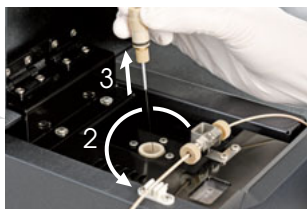
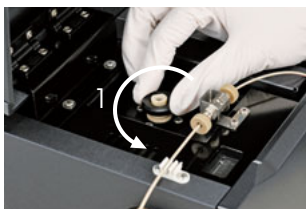

## ■ Newly Designed Ionization Unit

Designed without cables or tubes, removing the new ionization unit is simple: release a one-touch lever to open the unit and lift it out. In addition, no tools are needed to detach the needles fitted in APCI and DUIS units, allowing for easy maintenance.

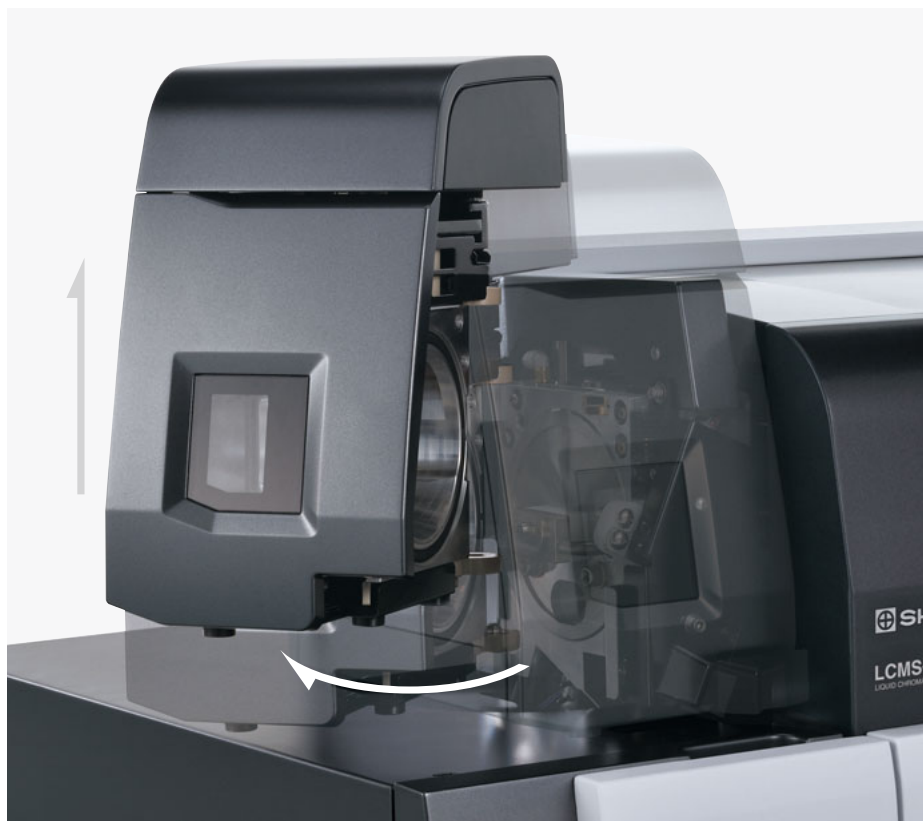

ESI-8050 (standard)



APCI-8050 (optional)



DUIS-8050 (optional)



# LabSolutions LCMS Ver. 5.6

LabSolutions LCMS is integrated workstation software used to control LCMS-8030/8040/8050 models, as well as Shimadzu HPLC/UHPLC systems from a single user interface. Equipped with a variety of data processing features, the software allows the creation of quantitation methods for multi-component analysis, enabling anyone to perform quantitative analyses with ease.

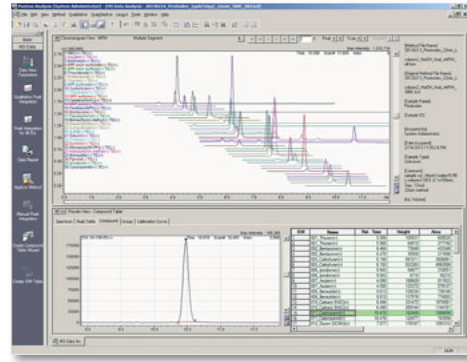

## Automatic Calculation of Dwell Time

The optimum dwell time is calculated automatically from the number of overlapping MRM channels and maximum loop time, thereby obtaining the necessary data points for the entire analysis.

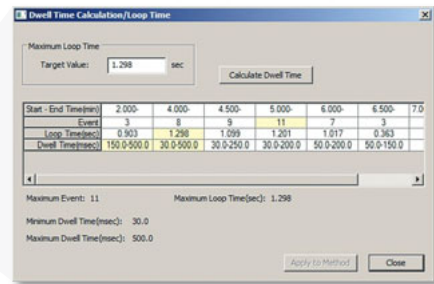
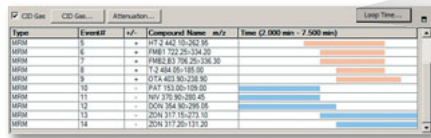

## MRM Optimization Functions

Flow injection analysis enables rapid and unattended optimization of MRM conditions for multiple compounds. The LCMS-8050 provides good optimization results even at high speeds.

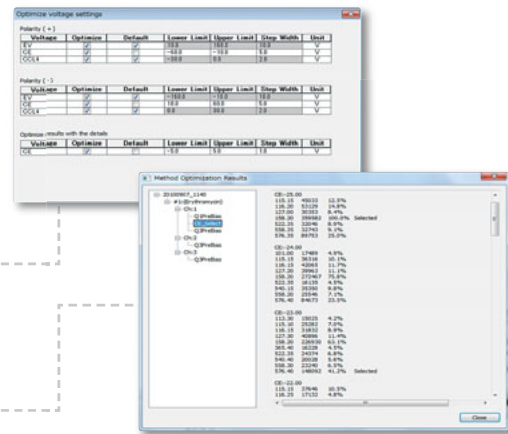
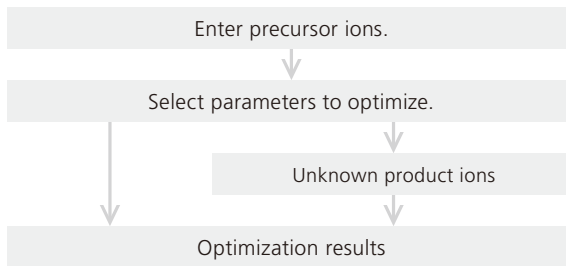

## Efficient Multi-Analyte Data Analysis

LabSolutions LCMS software incorporates a Data Browser that allows a user to analyze and compare multiple data sets in a single window. In addition, a Quantitation Browser enables efficient quantitative processing of multiple analytes.

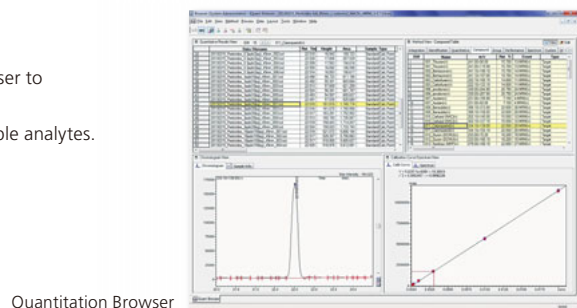









# Optional Software Programs

Shimadzu offers a variety of software options to address specific customer requirements. Combining LabSolutions LCMS with these programs improves workflow efficiency.

## Method Packages and MRM Library

A variety of method packages and MRM library, which include analysis conditions such as MRM parameters, enable efficient implementation of simultaneous multi-component analyses. The method parameter list included in these packages can be used to create methods that analyze targeted components only. These packages can save laboratories a great deal of method development time.

Note: Optimization of analysis parameters will be necessary in some cases when using the LCMS-8050.

Method Packages	Number of compounds	Method Packages	Number of compounds
Residual Pesticides 	167	Primary Metabolites Ver. 2 	55 <sup>*3</sup> + 97 <sup>*4</sup>
Veterinary Drugs 	42	Lipid Mediators Ver. 2 	158
Water Quality Analysis 	44 <sup>*1</sup> + 32 <sup>*2</sup>	Drugs of Abuse 	286
Rapid Toxicology Screening System Ver. 2 	161		

MRM Library	Number of MRM transitions
Metabolic Enzyme in Yeast <sup>*5</sup> 	3,584, including stable isotopes

- \*1 Golf course pesticides
- \*2 Pesticides targeted for water quality control
- \*3 Ion pair method
- \*4 PFPF column method
- \*5 It covers all 498 trypsin digested peptides of 228 types of enzymes derived from budding yeast.

## Quan Solution

Open Access Software for Triple Quadrupole LC/MS/MS Quantitative Analysis

Quan Solution allows users unfamiliar with LCMS software to perform LC/MS/MS analysis using pre-set methods. Utilizing a software wizard, it's possible to start analyses through the presentation of simple-to-follow on-screen instructions.

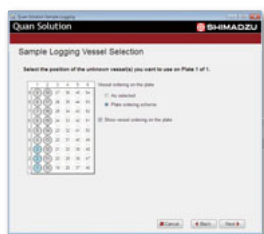

Load samples and start analyses in the laboratory.



Results emailed in PDF format to office.

## Profiling Solution

Software for Profiling Analysis

Used to compare and contrast the vast amount of data obtained from multiple chromatographic sets, this software extracts and tabulates all peaks found in multiple data files to create the peak tables required for multivariate analysis.



# HPLC Solutions for Mass Spectrometry

Shimadzu's wide-ranging HPLC portfolio encompasses all your analytical needs. Shimadzu offers the fastest and most reliable HPLC and UHPLC solutions.

## ■ Efficient Method Development

### Nexera Method Scouting

Nexera Method Scouting software automates method development using up to 96 unique separation conditions. Allowing up to 16 binary solvent combinations and up to 6 columns, intuitive and user-friendly screens allow the user to quickly select pump flows, gradient conditions, and column valve positions. A sequence table is automatically generated, and the user is spared the tedious and repetitive tasks of manual solvent blending, column removal, and gradient programming.

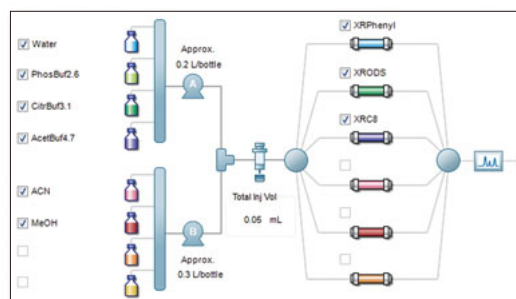

Column and mobile phase selection window

## Co-Sense Series

## ■ Direct Analysis of Drugs in Biological Samples

### Co-Sense for Bio-Analysis (BA)

Co-sense for BA is a 2-Dimensional HPLC system equipped with the Shim-pack MAYI-ODS pretreatment column and a unique on-line dilution bypass channel. The system's online sample preparation capabilities reduce labor costs and improve laboratory efficiency.

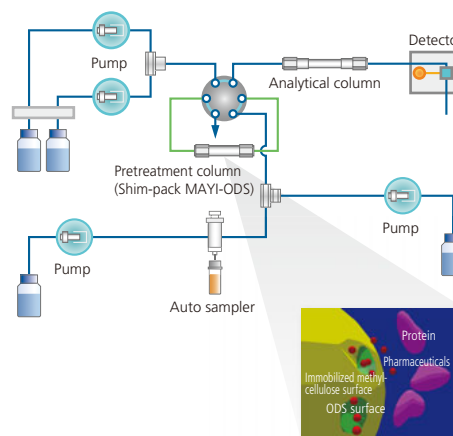

## ■ High Sensitivity Analysis of Minor Impurities

### Co-Sense for Impurities

Co-Sense for Impurities features an online trapping and solvent switching capability that allows traditional non-volatile separation techniques, such as phosphate buffer solutions and ion-pair reagents, to be incorporated into the mass spectrometry laboratory. Enhanced sensitivity is achieved through automatic online concentration of the target impurities.

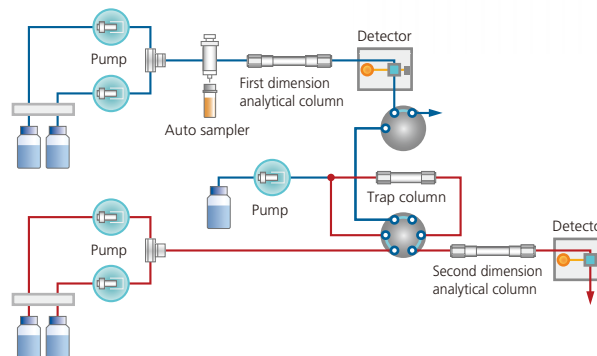

Providing Excellence in Data Quality and Improved Efficiency,  
Shimadzu's Unique Technologies Achieve a New Global Standard in Mass Spectrometry

*Speed Beyond Comparison*  
**UFMS**  
*ULTRA FAST MASS SPECTROMETRY*



The LCMS-8050 has been developed with advanced UF technology,  
and is the flagship model of the Shimadzu UFMS series,  
which features world-leading speed and sensitivity.

The LCMS-8050 is the ideal triple quadrupole LC/MS/MS system  
for High-sensitivity, high-throughput,  
and simultaneous quantitative and qualitative analysis.

Utilizing the same user-friendly interface as HPLC/UHPLC and GC modules,  
LabSolutions MS workstation software provides intuitive  
functionality for efficient data processing and an easier,  
more productive analytical workflow.



iMScope *TRIO* (page 19) may not be sold in your country. Please contact us to check the availability of iMScope *TRIO* in your country.



Shimadzu Corporation  
[www.shimadzu.com/an/](http://www.shimadzu.com/an/)

Company names, product/service names and logos used in this publication are trademarks and trade names of Shimadzu Corporation or its affiliates, whether or not they are used with trademark symbol "TM" or "®". Third-party trademarks and trade names may be used in this publication to refer to either the entities or their products/services. Shimadzu disclaims any proprietary interest in trademarks and trade names other than its own.

For Research Use Only. Not for use in diagnostic procedures.  
The contents of this publication are provided to you "as is" without warranty of any kind, and are subject to change without notice. Shimadzu does not assume any responsibility or liability for any damage, whether direct or indirect, relating to the use of this publication.