

Fourier Transform Infrared Spectrophotometer

IRAffinity-1S





IRAffinity-1S

IRAFFINITY-1S

SHIMADZU



IRAffinity-1S

Fourier Transform Infrared Spectrophotometer

Surpassing General-Purpose Instruments in
Sensitivity and Performance

Easy-to-Use, Advanced Software: LabSolutions IR

Broader Range of Applications

The IRAffinity-1S is a compact Fourier transform infrared spectrophotometer that is housed within an elegant form. The interferometer is continuously optimized by a dynamic alignment mechanism, and a built-in auto dryer helps ensure ease of maintenance. The IRAffinity-1S offers the high S/N ratio (30,000:1, 1-minute accumulation, neighborhood of $2,100\text{ cm}^{-1}$, peak-to-peak), a maximum resolution of 0.5 cm^{-1} , and compact dimensions. Furthermore, the high-performance LabSolutions IR software, which emphasizes operability, and analysis support programs (Contaminant analysis program and Pharma Report program) make it easier to perform data processing and analysis.

Applicable to Various Fields

IRAffinity-1S: Meeting the Needs of a Wide Range of Analyses

Fourier transform infrared spectrophotometers are used in numerous fields and applications; some of the most common ones are listed below. The IRAffinity-1S is a highly effective tool for these types of analyses*.

* Appropriate accessories and software for analysis are required in addition to the IRAffinity-1S.

Automobiles

- Material identification tests
- Analysis of contaminant
- Failure analysis

Chemicals and Polymers

- Raw material identification tests
- Qualitative analysis of plastics and rubber
- Identification of functional groups of synthetic products
- Analysis of surface preparation agents
- Analysis and thickness measurement of thin films
- Analysis of catalysts
- Analysis of paints and coatings
- Analysis of contaminant
- Quantitative analysis

Construction

- Material identification tests
- Degradation analysis of coatings

Food Products

- Raw material identification tests
- Packaging material identification tests
- Analysis of contaminant

Medicine

- Raw material identification tests
- Identification of functional groups of synthetic products
- Identification of functional groups of natural products
- Analysis of contaminant

Metals

- Qualitative analysis of thin films on metal plates
- Analysis and thickness measurement of thin films
- Analysis of contaminant

Electricity, Electronics, and Semiconductors

- Thickness measurement of epitaxial films
- Quantitative analysis of interstitial oxygen and substituted carbon
- Quantitative analysis of phosphorus and boron in BPGS
- Quantitative analysis of hydrogen concentration in nitride film
- Quantitative analysis of hydrogen concentration in amorphous silicon
- Detection of brominated flame retardants
- Analysis of thin films
- Analysis of contaminant
- Failure analysis
- Analysis of semiconductor gases

Cosmetics

- Material identification tests
- Analysis of contaminant
- Failure analysis

Realizing High Performance

Surpassing General-Purpose Instruments in Sensitivity and Performance

The IRAffinity-1S incorporates a high-throughput optical element and a dynamic alignment mechanism. These features allow the user to experience a level of performance that surpasses that of general-purpose instruments.

Highest S/N Ratio in Its Class: 30,000:1

Through the incorporation of a high-energy ceramic light source, a temperature-controlled, high-sensitivity DLATGS detector, a high-throughput optical element, and the optimization of the electrical system and optical system, the IRAffinity-1S achieves the highest S/N ratio in its class.

Highly Stable Interferometer Achieved with Dynamic Alignment Mechanism

The state of interference in an FTIR instrument is extremely delicate, and the interferometer must be controlled with high precision. With the IRAffinity-1S, the moving mirror is run very smoothly and precisely by a flexible joint system (FJS), and the interferometer is optimized and stabilized by an improved dynamic alignment mechanism. This makes it possible to perform measurement in a stable state with a short warming-up time.

Dynamic Alignment Mechanism (JPN patent No. 3613171)

The state of interference of the He-Ne laser used for sampling by the interferometer is continuously monitored and compared with the state under the optimum conditions previously recorded by the system. The difference between these states is calculated by an advanced digital signal processor, and the inclination of the fixed mirror is changed continuously in order to eliminate any difference. This feedback is even provided during sample measurement. There is also an automatic adjustment for the interferometer that performs this operation.

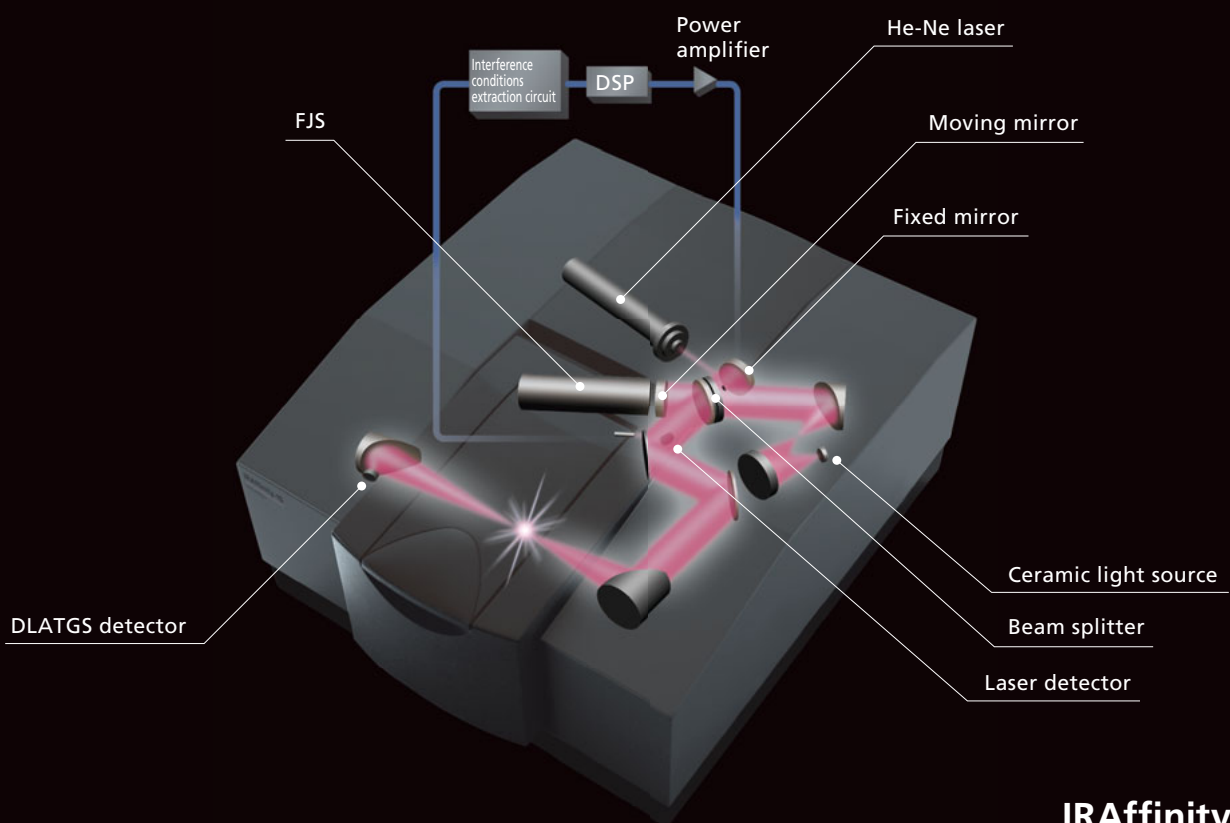

IRAffinity-1S

Fourier Transform Infrared Spectrophotometer

Easier Maintenance

Ease of Maintenance Ensured by Built-in Auto Dryer

(JPN registration of utility model No. 3116465)

Beam splitters in the interferometers of FTIR instruments are susceptible to humidity. In order to maintain the long-term stability of the interferometer, the beam splitter must be protected. In the IRAffinity-1S, the interferometer is airtight and incorporates a unique internal auto dryer.

Measures Taken to Protect the Optical Element in the Interferometer

- The interferometer has an airtight structure.
- Moisture inside the interferometer is continuously removed by an auto dryer.
- The beam splitter is coated with a moisture-resistant protective film.

Principle of the Auto Dryer

The IRAffinity-1S incorporates an auto dryer that electrolytically removes the moisture inside the interferometer using a solid polymer electrolyte membrane.

- When porous electrodes are attached to a solid polymer electrolyte membrane and direct current is applied, moisture on the anode side (i.e., the desiccation side) dissociates into hydrogen ions and oxygen.
- The hydrogen ions travel through the solid polymer electrolyte membrane and reach the cathode side (i.e., the moisture discharge side).
- At the cathode, the hydrogen ions react with oxygen in the air to form (gaseous) water vapor, which is released outside the interferometer.

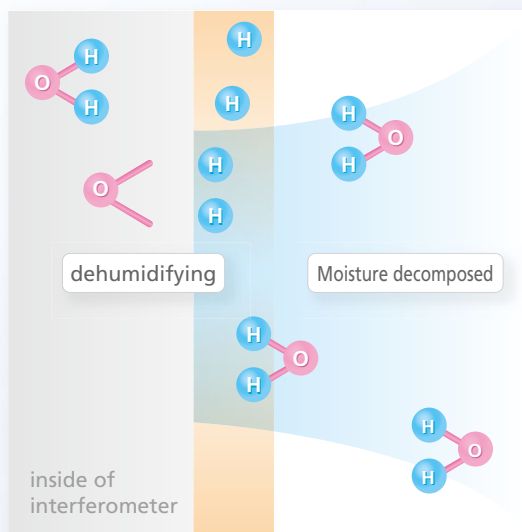

Anode (desiccation side)

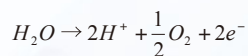

Cathode (moisture discharge side)

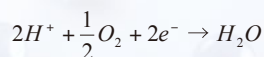

Increased Reliability Achieved by Instrument Monitoring

In order to increase reliability, not only does the IRAffinity-1S execute self-diagnosis at initialization, it also monitors the state of the instrument during operation. It is also possible to check basic performance using a validation program that is incorporated as a standard feature.

Sequential Display of Diagnostic Results

The IRAffinity-1S executes self-diagnosis at instrument initialization, in which it checks the electrical, signalling, and optical systems. If the interference conditions are poor, they are adjusted and optimized using the dynamic alignment mechanism. Additionally, the light source, the He-Ne laser, humidity, information related to accessories, and the auto sample changer settings are continuously monitored by the status monitor function. If accessories are installed, they are automatically identified, and the optimum measurement conditions are set*.

These diagnostic and monitor results are recorded in logs.

*Only when QuickStart accessories are installed.

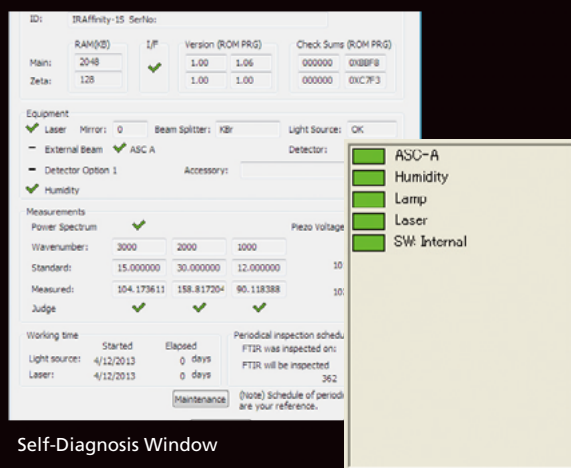

Self-Diagnosis Window

Status Monitor Window

Validation Program

The IRAffinity-1S is equipped with a validation program that complies with the European and Japanese Pharmacopoeias and with ASTM (American Society for Testing and Materials). This validation program checks the basic performance of the instrument using a polystyrene film, and creates reports of the results.

- Test Items Complying with the European and Japanese Pharmacopoeias

- Shape and intensity of a power spectrum
- The following items for a polystyrene spectrum:
 - Resolution
 - Wavenumber accuracy
 - Wavenumber reproducibility
 - Transmittance (absorbance) reproducibility

- Test items for ASTM (ASTM 1421 Level Zero)

- Energy intensity test based on power spectrum
- Noise test based on 100% transmittance spectrum
- Reproducibility test based on polystyrene spectrum

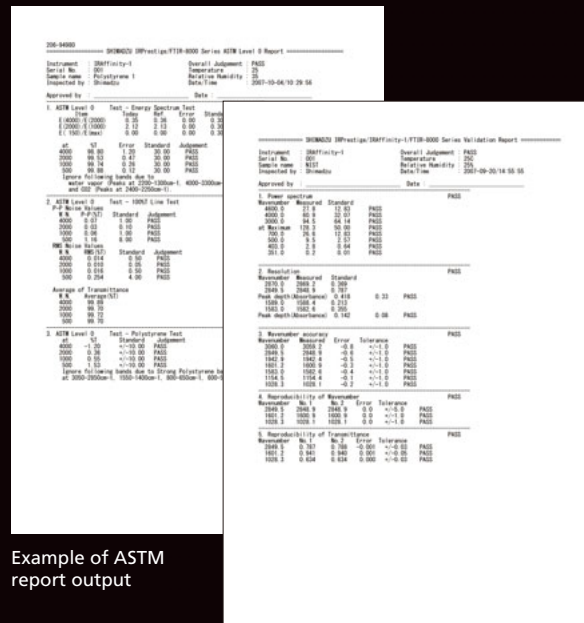

Example of ASTM report output

Example of Japanese Pharmacopoeia report output

New Generation of Workstation

LabSolutions IR, a member of the LabSolutions family, has been optimized for network applications, includes an extensive library of spectra, and features a high-performance search function. In addition, Macro functions provide automation and labor savings.

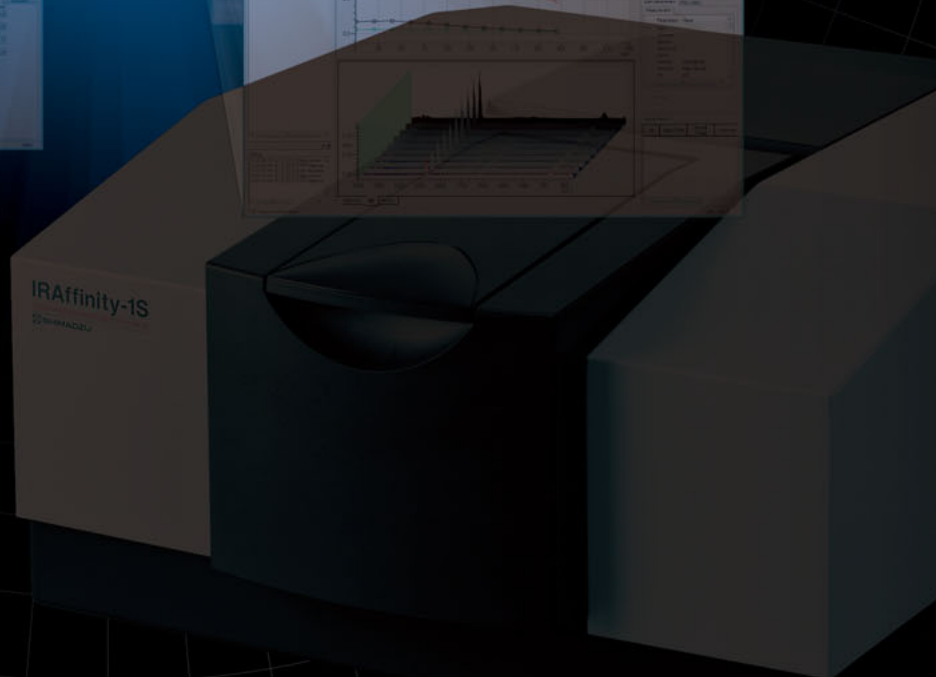
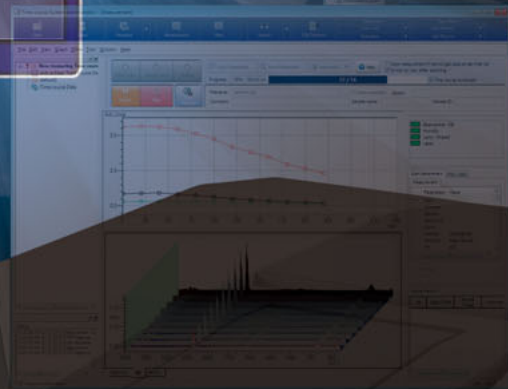
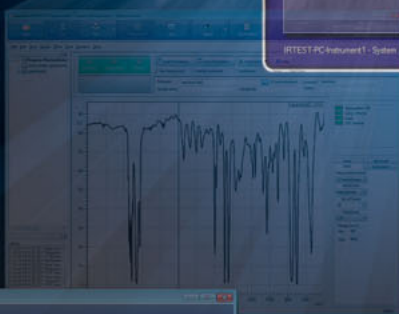
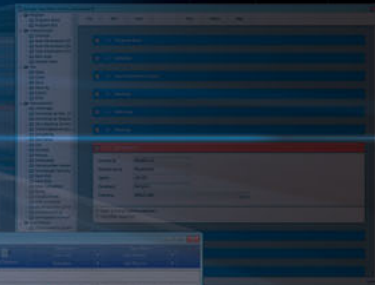
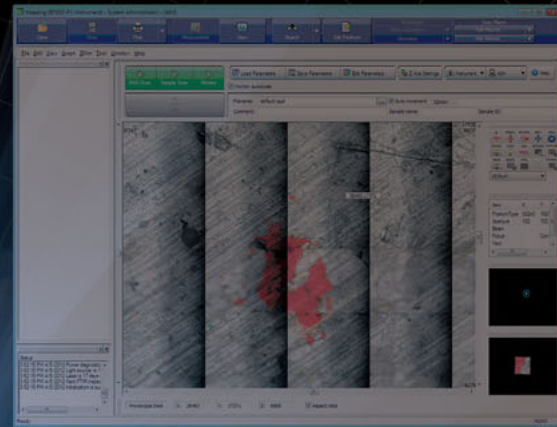
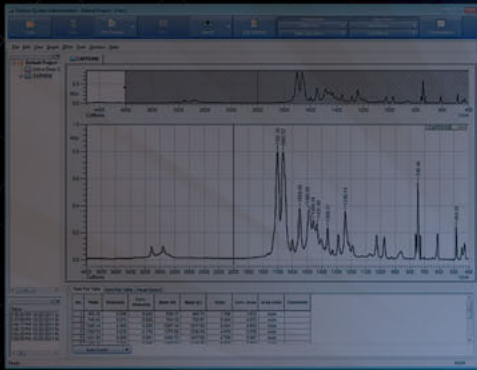

Fast, Easy-to-Use LabSolutions IR Series Software

LabSolutions IR easily executes FTIR operations such as scanning, data manipulation, quantitation, reporting, saving, user administration, and more. High-level administrative functions and a variety of data manipulation functions provide for an easier, more user-friendly analysis environment. In addition, numerous optional programs are available to address all modern laboratory needs.



Launcher

Run Dedicated LabSolutions IR Programs or Windows Applications Easily with the Dedicated LabSolutions IR Launcher.

LabSolutions IR includes a number of dedicated programs, including Postrun, Spectrum, and Quantitation, which are easily launched using the LabSolutions IR Launcher. In addition, macro programs and Windows applications can be registered with the LabSolutions IR Launcher for quick and easy start-up.

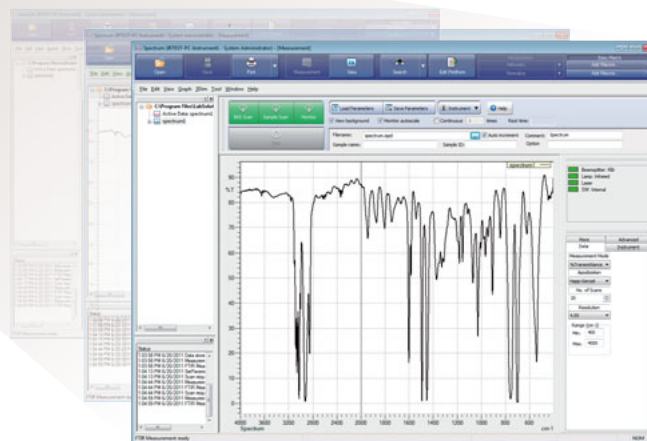

Excellent Features of LabSolutions IR Series

Network Features

- ▶ High-level security and user administration functions.
- ▶ Suitable for ERES regulations such as FDA 21 CFR Part 11, PIC/S, and more.
- ▶ Management of FTIR as well as LC and GC data by the server on a network.
- ▶ With terminal service, LabSolution IR can be controlled from a client PC without installing LabSolutions IR on it.

Extensive Spectra Library and High-Performance Search Function

- ▶ Features a library containing approximately 12,000 spectra.
- ▶ Enables high-quality searching with standard libraries.
- ▶ High-performance search methods, including Spectral, Text, Combination, and Peak searches.
- ▶ Shimadzu's unique search algorithm provides precise search results.

Macro Program Functions Provide Automation and Labor-Savings

- ▶ Simply align steps to create a Macro program.
- ▶ Automated identification tests and contaminants analysis.

Programs

- ▶ Postrun, Spectrum, Quantitation, Photometric, Time course (option), Mapping (option)
- ▶ All of the Postrun and measurement programs have a common Main toolbar, Menu, Measurement toolbar, Tree view, and Log window. The operation of each program is also similar, providing a familiar feel no matter what task you are working.

Reporting

- ▶ Easy printing using the ViewPrint function and Free-layout reports.

Data Manipulation

- ▶ A wide variety of data manipulation functions, including Advanced ATR correction and Kubelka-Munk conversion, and quantitation functions, such as the multi-point calibration curve method and CLS method, are standard.

Solutions Achieved with LabSolutions IR Series

Designed to solve problems that can arise in laboratories!

Provides a Comfortable Operating Environment

- ▶ The equipment operating status in a network is available at a glance.
- ▶ Analysis is possible from PCs other than the analysis PC.
- ▶ An enormous quantity of data can be quickly searched.

Safe and Secure Data Management

- ▶ Database management prevents mistakes.
- ▶ Solid security

Control and Analysis are Possible from PCs Other than the Analysis PC

With LabSolutions CS, equipment can be accessed freely, from any location, while maintaining security. For example, before starting an analysis, the equipment can be operated from a PC in the laboratory. After analysis starts, a PC in the office can be used to confirm operating status and analyze the data. This improves the efficiency of analysis status monitoring, report creation and other procedures.

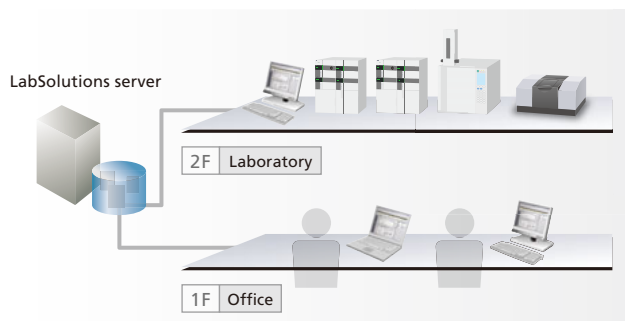

More Efficient Managerial Procedures

- ▶ System information, including data and users, is integrated with a server.
- ▶ Pertinent information is managed for every project.

Total Support for Regulatory Compliance

- ▶ Support functionality for CSV (IQOQ validation) procedures.
- ▶ With terminal service, the configuration management of LabSolutions software in a client PC is unnecessary.

Database Management Prevents Mistakes

With LabSolutions DB and CS, the analysis data is managed securely by the database. Overwriting, deletion and other mistakes typical of data file management do not occur. In addition, when postrun analysis is performed using the acquired data, postrun analysis data revision numbers are automatically assigned, preventing the accidental overwriting of raw data.

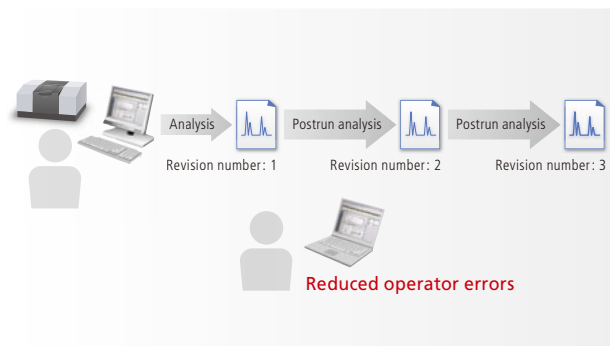

System Information, Including Data and Users, Is Integrated with a Server

Currently, since user information is managed for every PC, as the number of PCs increases, so too does the burden on the administrator. LabSolutions CS provides integrated server-based management of user information. As a result, user management is not required individually for each PC, reducing the administrator's time and effort.

Data backup is also important. Since the data can be managed with a server, data does not remain in each PC. It can be stored on the server or saved to media such as a DVD. The data can be referred to

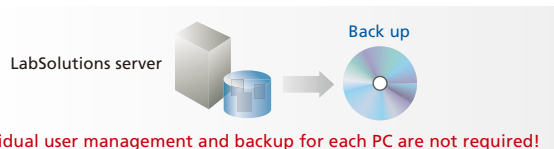

directly, without returning to the original database. (Restoration unnecessary).

Solid Security

An audit trail to ensure the reliability of data and document e-mail transmission functions when any event occurs in the system can be set up. User accounts are managed using passwords, where password length, complexity and term of validity must satisfy specified requirements.

It is also possible to set lockout functions to prevent illegal access, and set a registered user's deletion and change. In addition, a box can be selected to prevent overwriting a data file, and outputting an item to a report can also be performed.

||| LabSolutions IR Series |||

LabSolutions IR

LabSolutions IR is a File Based FTIR Control and Analysis Software. This blended software package incorporates the improved software from IRsolution with LabSolutions' administration functions. The software is designed to improve operation and data processing for a more user-friendly environment. LabSolutions IR can also be connected with the conventional CLASS-Agent system.



LabSolutions DB IR

LabSolutions DB IR allows for Secure Data Management by integrating a data management function with LabSolutions IR. Compliant with ER/ES regulations, the software is optimally configured for customers using a PC. It is recommended for facilities that do not require network connections and want to be ER/ES compliant.



LabSolutions CS

LabSolutions CS is Freely Accessible to the Analysis Network, eliminating the need for connecting a PC to the instrument. Since all the data is managed on a server, LabSolutions CS can be read from any personal computer on a network. With terminal service, LabSolutions IR can be controlled from a client PC without installing LabSolutions IR on it. It is recommended for facilities that have a large number of users, manage data in a database, and want to be ER/ES compliant.

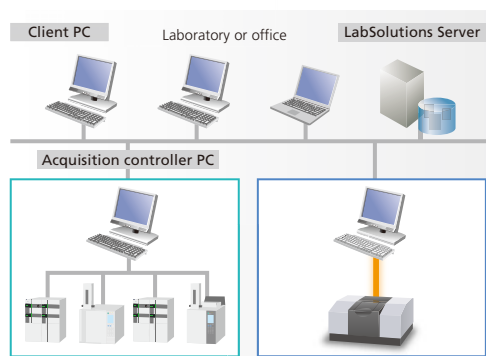

Name	LabSolutions IR	LabSolutions DB IR	LabSolutions CS
Data management method	Measured data files are saved and managed in folders on the PC.	Measured data files are saved and managed in the LabSolutions database.	
Data references	The software references files on drives or in folders on the PC.	The software references files in the database.	
LabSolutions database	Unavailable	Available (The database resides on a local PC)	Available (The database resides on a server)
CLASS-Agent database	Available (Option)	Unavailable (The contents of the CLASS-Agent database can be transferred to the LabSolutions database.)	
User administration		Available	
Rights group administration		Available	
Project administration	Unavailable	Available	
Standalone/network	Either can be used.	Only the standalone configuration can be used.	Only databases on the network can be used. (LabSolutions IR data can be viewed using the database manager on a PC set up for viewing purposes. Note that LabSolutions IR must be installed on the PC used for viewing.)
Data backup	Performed on a file-by-file basis using Windows Explorer.	Performed for each database.	

Extensive Spectra Library and a High-Performance Search Function

Features a library containing approximately 12,000 spectra.
Enables high-quality searching with standard libraries.

Approx. 12,000-Spectra Library

A wide variety of libraries, including Shimadzu's unique libraries, reagents, polymers and more, is included standard.
Searching with standard libraries provides high-quality search results without purchasing extra libraries.

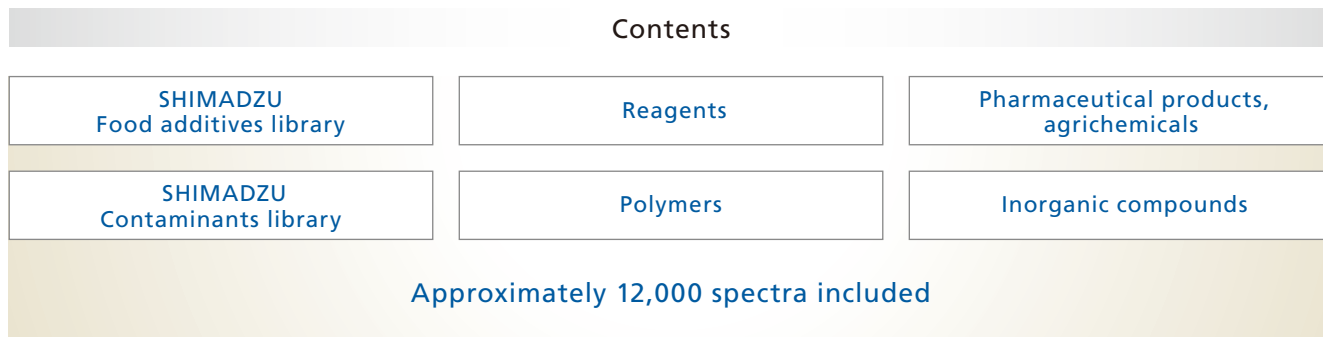

High-Performance Search Functions

Obtain high-quality search results with four high-performance search methods (spectral search, peak search, text search and combination search) and a library containing 12,000 spectra.
Libraries created on IRsolution and HYPER-IR and commercial libraries

such as Sadtler and S.T. Japan can also be used.
Simply dragging spectra into a library creates a user library. In addition, editing spectral information or deleting a spectrum is very easy.

Search functions

Spectral search

Shimadzu's unique search algorithm provides accurate results.

Peak search

If you only have an old spectrum chart, searching can be performed with peak wavenumbers without a spectrum file.

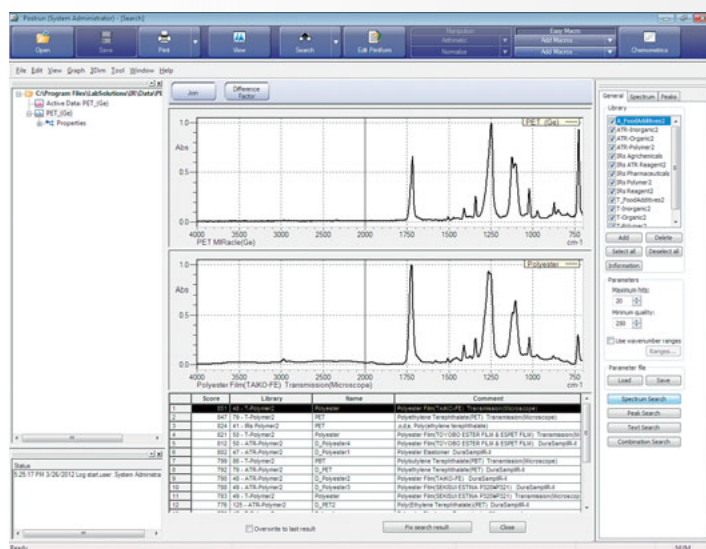

Contaminant Analysis Program

By combining Shimadzu's own algorithms (patent pending) with that of library spectra for common contaminants, this program identifies contaminants with a high degree of accuracy. Reports are automatically created after analysis, thereby reducing post-processing time to a few seconds.

With automated reporting, this easy-to-use program allows operators with little FTIR knowledge to perform analysis easily.

4 features of the Contaminant analysis program

Contains spectra for over 500 highly-selected inorganic substances, organic substances, and polymers that are often detected as contaminants in Shimadzu's Analytical Applications Department.

Allows automation of the process, including searching, judgment evaluation, and report creation.

Incorporates algorithms that focus on spectral characteristics, rather than performing simple spectrum searches.

Major and Minor components are found and their ranks are displayed.

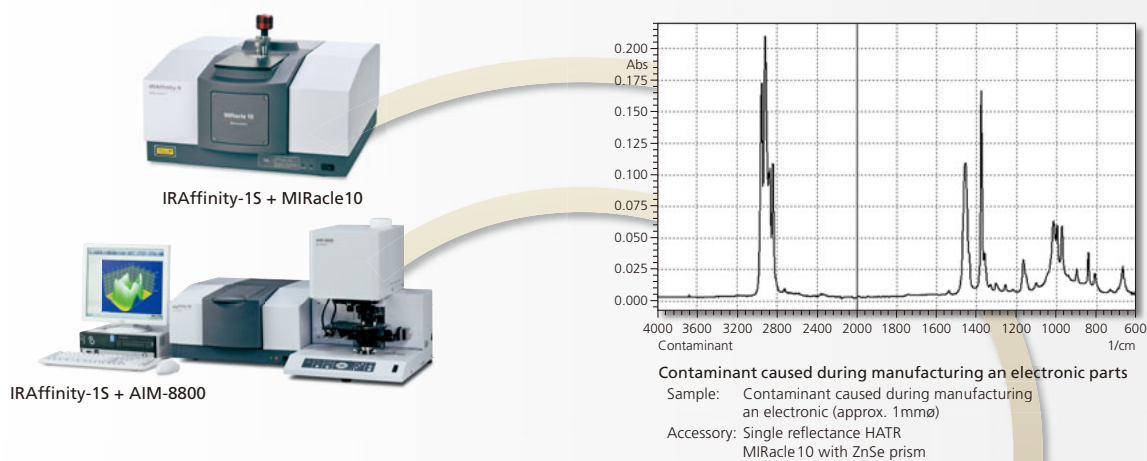

<<< Identification Report >>>

Major Components
 (+++) TALG 1
 (+++) Polypropylene (PP) 1
 (+++) Polypropylene

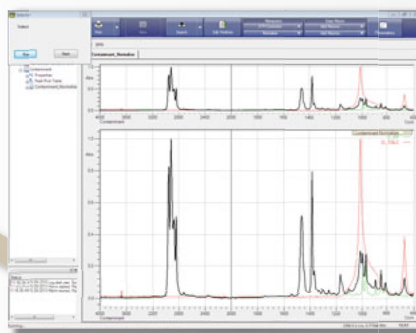

Major Components
 (+++) TALG 1
 (+++) Polypropylene (PP) 1
 (+++) Polypropylene
 (++) TALG 2

Accessory Components

Automation and Labor-Savings with Macro Program Functions

LabSolutions IR automates routine work, such as scanning, data manipulation, reporting, identification tests, and contaminants analysis. Launch programs from the Launcher or your PC desktop.

Easy Macro — Just a Single Click Launches Routine Work

The “Easy Macro” function will create macros that are suitable for routine work, particularly when repetitive operations are used. The macro builder allows macros to be constructed by simply selecting and aligning operations from a list. Once constructed, the macros can be registered with the Launcher and Desktop for quick execution. Operators who are not familiar with FTIR can easily operate the instrument.

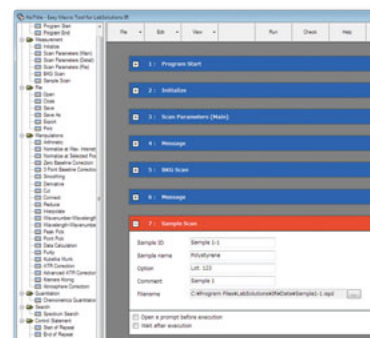

Easy Macro Operations

- ▶ Initialization of FTIR, configuration of scan parameters, spectrum measurement
- ▶ Data manipulations, search, quantitation, printing
- ▶ Repeat measurements, displaying messages, alarm sounds, external program execution

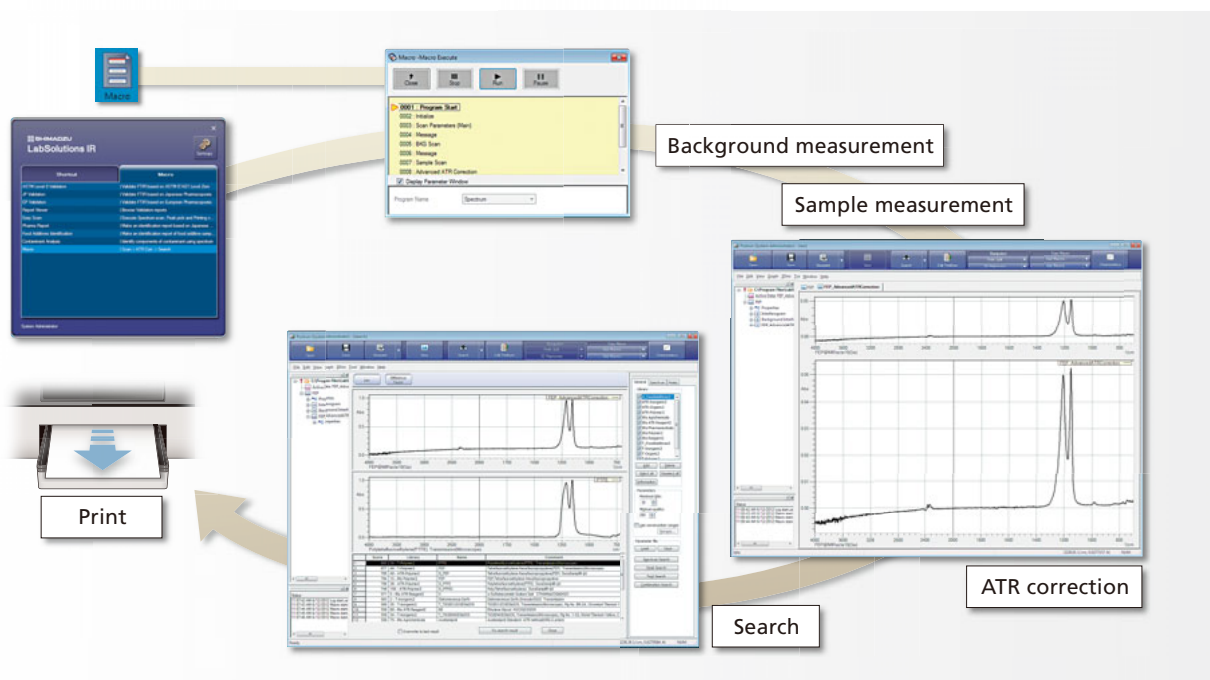

The use of macro programs means automation and labor-saving improvements in the execution of the following analytical work.

- ▶ **Routine tasks consisting of measurements, peak detection, and printing**
 - Common, routine tasks for IR analysis can be performed with a single click.
- ▶ **Japanese Pharmacopoeia and food additive identification tests**
 - Automatic pass/fail testing of inspection samples
- ▶ **Contaminant Analysis**
 - Easy and quick contaminant analysis. Analysis results are provided in Only a few seconds.
- ▶ **Validation program that complies with the Japanese, European, Chinese, and United States Pharmacopoeias, and with ASTM**
 - Easy undertaking of instrument inspections in accordance with official regulations

Identification Test Program

This program makes pass/fail judgments about samples in accordance with the tests specified in the Pharmacopoeia. In addition to identification tests for pharmaceutical products, this program can be used for incoming inspections and pre-shipment inspections.

4 features of the Identification test program

Prints out the spectra for standards and samples in order to facilitate easy comparison.

Calculation of the differences between the peak wavenumbers for standards and samples, differences in intensity ratios between peaks, pass/fail judgments, and print out of reports.

Detection and printing just the peaks that are specified for pass/fail judgment.

Spectra of 57 samples on Japanese Standards of Food Additives are stored in LabSolutions IR.

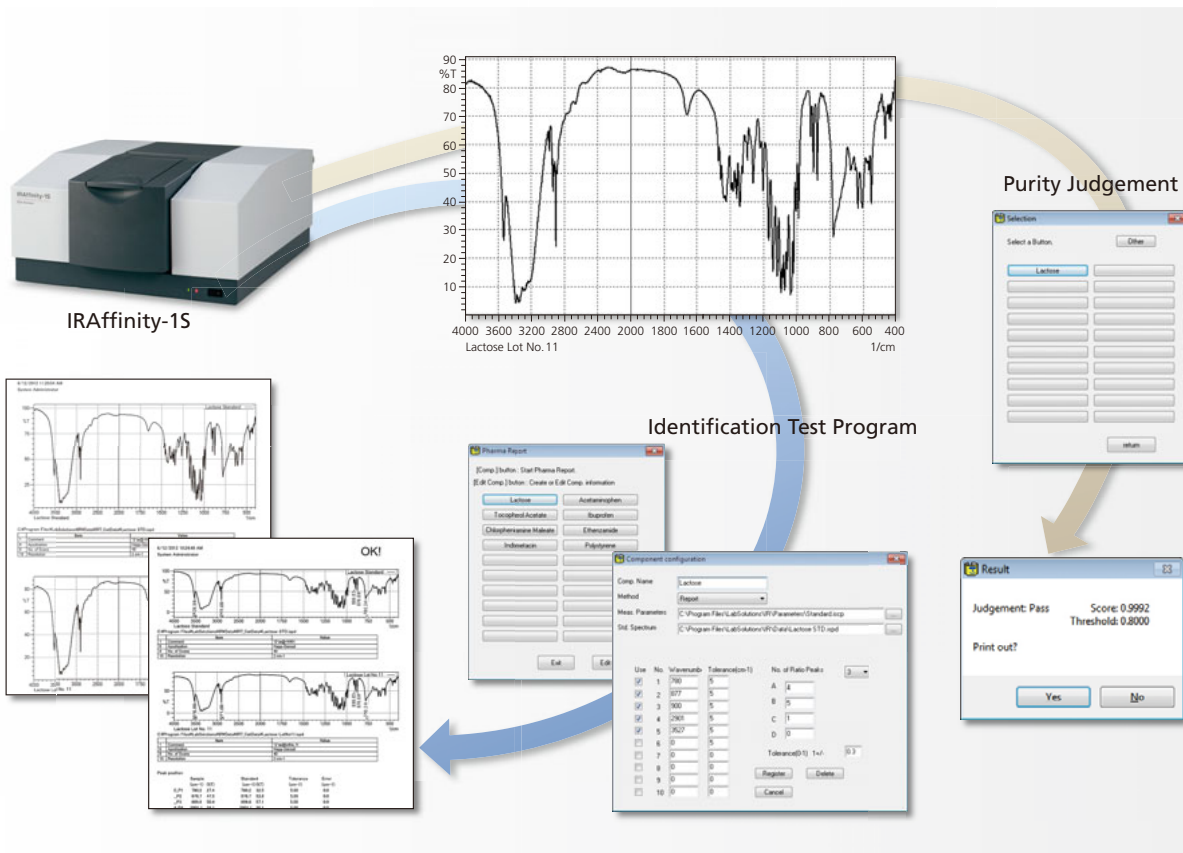

Purity Judgement

The Purity Judgement calculates the similarity (Purity) between a reference spectrum and a test spectrum, and judges Pass or Fail. It judges similarity of spectra in a quantitative way.

Software Options

LabSolutions IR incorporates data processing functions such as Advanced ATR correction and Kubelka-Munk conversion, quantitation functions such as the multi-point calibration curve method and the CLS method, as well as the spectral searching function as standard features. However, adding the following optional software products makes it possible to further increase the application range.

LabSolutions IR

Time course software

(P/N 206-74558-91)

The time course program is used to collect spectra in regular intervals and creates a time course dataset used to follow reactions as a function of time. Changes in peak height and peak area can be used to calculate values related to reaction kinetics. Time course information is saved and displayed in 3D (bird's eye view) or in a contour plot. It can be recalculated by modifying parameters.

The scan interval is dependent on resolution, number of scans and mirror speed. The fastest speed under a 16cm^{-1} resolution and a mirror speed of 9mm/s is 7 seconds for 1 accumulated scan. Maximum measurement time is 48 hours but it depends on scan parameters. The time course software includes a 3D Processing program.

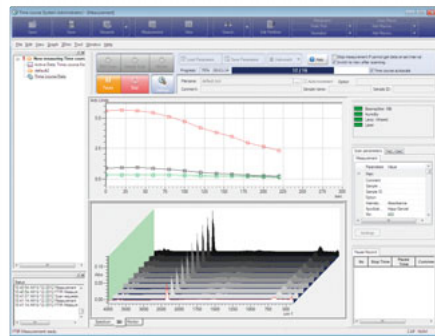

LabSolutions IR

Mapping program

(P/N 206-74559-91)

The Mapping software allows one to map absorption information on a sample surface as a function of position when using the Shimadzu AIM-8800 Infrared Microscope.

Mapping parameters, such as the mapping range, the scan intervals, and the background positions, can be set on the composite images. Area mapping, line mapping and random mapping modes are supported.

In addition to mapping in the conventional transmittance and reflectance modes, micro-ATR mapping with an optional ATR objective is also available. From the acquired mapping data, it is possible to extract spectra and to perform calculations for functional-group mappings for specific peaks. The data can be displayed as 3D images or contour plots, or in spectral overlay mode.

Mapping program includes a 3D Processing program.

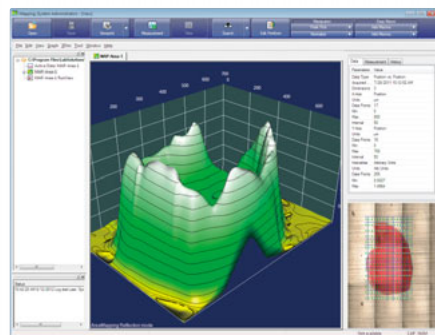

CLASS-Agent connection kit

(P/N 206-74557-91)

This is a program to connect LabSolutions IR (File edition) to the CLASS-Agent system. Spectra collected using LabSolutions IR are managed in an existing CLASS-Agent database. The database enables data management for the entire recording life cycle, which consists of the creation (measurement), inspection, approval, storage, browsing, backup, and disposal of analysis data. CLASS-Agent Manager and Public Agent are required.

* Only spectra are saved in the CLASS-Agent database. Mapping data, Time course data, Calibration curve and Quantitation result tables cannot be stored.

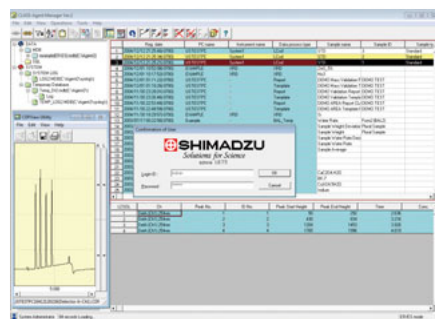

LabSolutions IR

PLS Quantitation program

(P/N 206-74560-91)

PLS (partial least squares) quantitation is a chemometrics method that, like multiple linear regression analysis, is widely used for the simultaneous quantitation of multiple components. The PLS quantitation program incorporates PLS I and PLS II methods. It is possible to display calculation values based on input values. PLS factors are based on "PRESS" values, loading vectors, and score values. Analysis can be performed on the regression equations obtained with the PLS method.

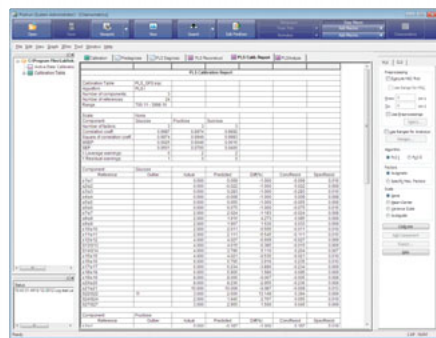

LabSolutions IR

Curve-Fitting (Peak-Splitting) program

(P/N 206-74561-91)

Usually, absorption bands in infrared spectra consist of overlapping peaks. The curve-fitting (peak-splitting) program can be used to separate absorption bands into individual peaks, separate peaks that have been influenced by hydrogen bonding, and identify the peaks of functional groups that are hidden by absorption bands. Six types of curves, such as Gaussian, Lorentzian, and Gaussian+Lorentzian, are available for separation analysis.

The curve can be selected in accordance with the form of the peaks in the absorption band. The separated component peaks are displayed together with the resultant spectra, making it possible to accurately evaluate the separation.

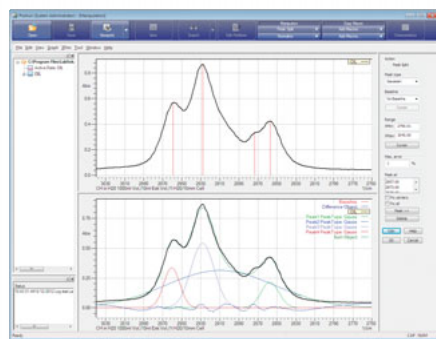

LabSolutions IR

3D processing program

(P/N 206-74563-91)

The 3D processing program offers the following functionality

- ▶ **Changes the method of displaying data**
 - Data can be displayed in bird's eye view (3D), as an intensity distribution or using contour lines, as a spectral overlay, or rotated.
- ▶ **3D data processing**
 - Changes at specific wavenumbers can be isolated.
 - Functions include data extraction, data points thinning, smoothing, zero-baseline, background correction, normalization, log conversion, first- or second-order derivative, and ATR correction.
- ▶ **Creation of 3D data from spectra**
 - Spectra measured at fixed intervals, such as by repeated measurements, can be arranged consecutively to create 3D data.

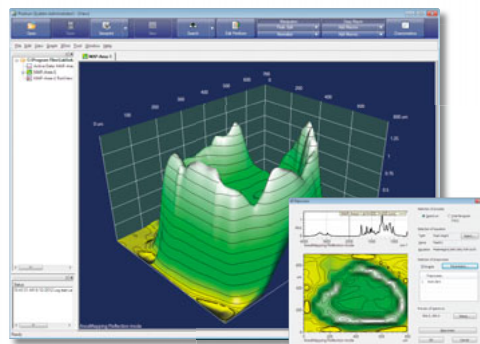

* The 3D processing program cannot control mapping measurements or AIM-8800 series infrared microscopes.

LabSolutions IR

Macro platform

(P/N 206-74562-91)

The Macro Platform is required to run the customized macro programs created by Shimadzu (for a fee). If, for example, you wish to perform routine work in which certain functions are used

in a pre-determined order, or you wish to run an automatic measurement system in combination with an auto sample changer, please contact your SHIMADZU representative for details.

A Wide Range of Accessories

If an accessory is installed in the sample compartment, the name and identification (machine) number of the installed accessory is displayed in IRsolution.

In addition to being displayed on the status monitor, it is also recorded in the log file.

The optimum measurement parameters for the installed accessory are automatically set.

This is a series of horizontal ATR accessories integrated with sample compartments. The ease of purging has been improved, and there is no concern with dust entering the IRAffinity-1S sample compartment.



MIRacle 10

(P/N 206-74127-xx)

This is a single-reflection ATR accessory. To measure the spectrum of a liquid, simply drip it on the prism. To measure the spectrum of the surface of other samples, clamp them firmly on the surface of the prism. Large samples (with a large surface area) can be measured without cutting them. The incidence angle is 45°.

Select from three types of prism: ZnSe, Ge, and diamond/ZnSe. Also, select whether the respective prism is equipped with a pressure sensor. The Ge prism is ideal for samples with a high refractive index.

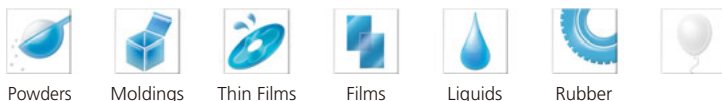

Powders

Moldings

Thin Films

Films

Liquids

Rubber



(P/N 206-74128-91)

GladiATR 10

(With pressure sensor P/N 206-74128-93)

This is a single-reflection ATR accessory. Since the prism is made solely of diamond, it is capable of measuring spectra up to 400 cm^{-1} . To measure the spectrum of a liquid, simply drip it on the prism. To measure the spectrum of the surface of other samples, clamp them firmly on the surface of the prism. The incidence angle is 45°. Select whether the prism is equipped with a pressure sensor. The Ge prism is ideal for samples with a high refractive index.

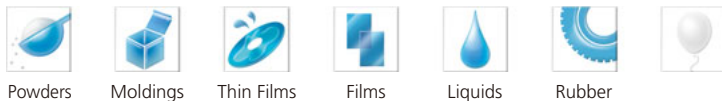

Powders

Moldings

Thin Films

Films

Liquids

Rubber



(P/N 206-74126-91)

HATR 10

This is a horizontal ATR accessory. There are prisms for liquids and solids. To measure the spectrum of a liquid sample, simply drip it on the prism. To measure the spectrum of the surface of film and rubber samples, clamp them firmly on the surface of the prism. The incidence angle is 45°, and the number of reflections is 10.

The ZnSe prism is included as standard, but the Ge prism is ideal for samples with a high refractive index.

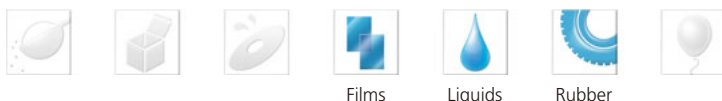

Films

Liquids

Rubber



DRS-8000A

(P/N 206-62301-58)

Although powder samples are mixed with KBr, as with the KBr pellet method, they are analyzed in their original state. It is not necessary to create pellets. For plastic moldings, part of the surface is scraped off with the emery paper attached to the SiC sampler (P/N 200-66750), and the powdered sample formed on the paper is analyzed. Diffuse reflectance spectra that are similar to transmittance spectra are produced by Kubelka–Munk conversion.



SRM-8000A

(P/N 206-62304-91)

A specular reflectance accessory with a 10° incidence angle is used for the analysis of thin films on a metal plate with a mm order of thickness. In the case of mirror-like plastic samples, the light specularly reflected from the sample surface is measured. Specular reflectance spectra that are similar to transmittance spectra are produced by Kramers-Kronig analysis.



RAS-8000A

(P/N 206-62302-91)

A high-sensitivity reflection measurement accessory with incidence angles of 70° and 75° is used for the analysis of thin films on a metal plate with an nm order of thickness. Using it in combination with the GPR-8000 infrared polarizer (P/N 206-61550) enables measurement with an even higher level of sensitivity.

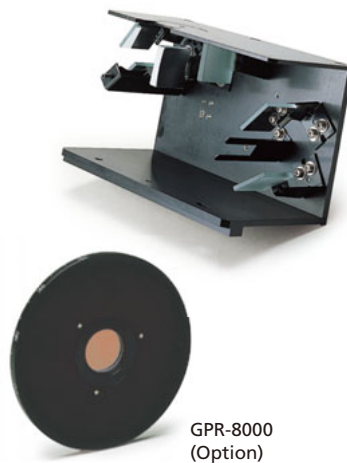

ATR-8000A

(P/N 206-62303-91)

This accessory obtains spectra for the surfaces of film-like samples that are clamped firmly on the surface of a prism. Incidence angles of 30°, 45°, and 60° can be selected. The KRS-5 prism is standard. A Ge prism is also available for samples with a high refractive index.

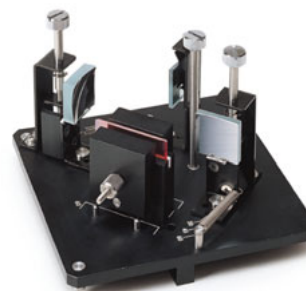
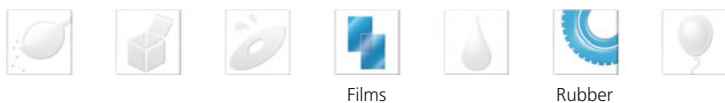

* ATR spectra similar to transmittance spectra are produced by ATR correction.

5-cm Gas Cell
10-cm Gas Cell
Long-Path Gas Cell

(P/N 202-32006-XX)
(P/N 202-32007-XX)

Gas cells are used for the analysis of gas samples, and the path length is selected according to the concentration. There are gas cells with short path lengths of 5 or 10 cm, and long path lengths of 10 m or more. Please contact your Shimadzu representative for details on long-path gas cells.



5-cm gas cell

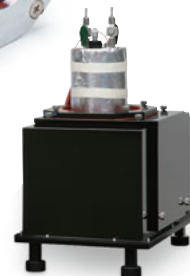

Long-path gas cell



Gases

Accessories for Automated Analysis

An automatic measurement system can also be configured using an autosampler. The autosampler is controlled by IRsolution.

ASC-8000T

(P/N 206-63900)

An auto sample changer that can perform automatic transmission measurement for up to 18 KBr pellets with a diameter of 13 mm. Film holders and cell plates for Nujol mulls are available as options.



Powders

Films

Liquids



DRS-8010ASC

(P/N 206-62308)

An automatic diffuse reflectance accessory that can automatically analyze up to 24 powder samples.



Powders



Sample Switcher 21

(P/N 206-63663-92)

Transmission-type sample switcher that switches between the sample and the background.

* This accessories is not applicable CE marking.
Please check with your Shimadzu representative for detail.



Powders

Films

Liquids

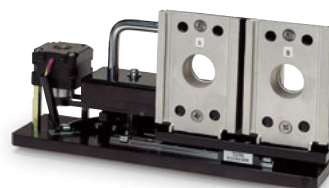

* An optional ASC cable is required.



Minute Samples

Accessories for Minute Samples

A single-reflection ATR accessory, such as a MIRacle or DuraSampIR, is useful for the analysis of sample sizes of the order of a few mm. The sample is taken out, placed on a prism, and firmly secured with the clamp provided.

An infrared microscope is useful for the analysis of sample sizes from a few mm down to approximately 10 μm .

In addition to transmission and reflection modes, the ATR mode is also available, enabling the analysis of various forms of minute samples.

IR Microscope AIM-8800

(P/N 206-73700-92/96/38/39)

The AIM-8800 is an infrared microscope that is installed on the right side of the IRAffinity-1S. It incorporates a bright, optimized optical system and a high-sensitivity MCT detector, enabling the high-sensitivity analysis of minute samples. It is full of functions, such as the auto aperture and auto focus functions, which greatly simplify the analysis of minute samples. It is possible to switch between measurement in the sample compartment of the IRAffinity-1 and measurement with the infrared microscope using IRsolution software.

Features of AIM-8800

- Incorporates a bright, optimized optical system and a high-sensitivity MCT detector to enable high-sensitivity measurement.
- The auto aperture, auto centering, and auto X-Y stage functions simplify determination of the desired analysis location.
- The auto focus function makes focusing simple.
- Up to 10 sample positions and 2 background measurement positions can be stored in memory.
- All microscope operations, such as stage movement, aperture setting and focusing, and switching between transmission/reflection and measurement/observation modes, can be controlled from the computer screen.
- Operation is also possible from the microscope's own keyboard.



ATR Objective (Slide-On Type) ATR-8800M (P/N 206-70450-91)

A single-reflection ATR objective that uses a semicircular Ge prism with a diameter of 3 mm is used when performing ATR measurement with the AIM-8800 infrared microscope. The prism is slid to one side when the sample is observed, and slid back into position for measurement.



Other Accessories

In addition to original Shimadzu accessories, unique FTIR accessories and software products from all over the world can be used. Please contact your Shimadzu representative about accessories that do not appear in this catalog. We will provide details on accessories that are appropriate for specific samples and applications. Also note that it may not be possible to use FTIR-8000 series accessories. If necessary, please check with your Shimadzu representative.

Specifications

Hardware

Interferometer	Michelson interferometer (30° incident angle) Equipped with dynamic alignment system (JPN patent No. 3613171) Sealed interferometer with auto dryer (JPN registration of utility model No. 3116465)
Optical system	Single-beam optics
Beam splitter	Germanium-coated KBr
Light source	High-energy ceramic light source with 3 years guaranteed
Detector	DLATGS detector equipped with temperature control mechanism
Wavenumber range	7,800 to 350 cm^{-1}
Resolution	0.5, 1, 2, 4, 8, or 16 cm^{-1}
S/N ratio	30,000:1 or higher (peak-to-peak, 4 cm^{-1} resolution, in a neighborhood of 2,100 cm^{-1} , 1-minute accumulation)
Mirror speed	4-step selection of 2.0, 2.8, 5, or 9 mm/sec
Data sampling	He-Ne laser
Gain	Automatic or manual setting ($\times 1$ to $\times 128$)
Sample compartment	Equipped with automatic accessory recognition mechanism W200 \times D230 \times H170 mm Center focus
Dimensions	W514 \times D606 \times H273 mm
Weight	35 kg

Dimensions

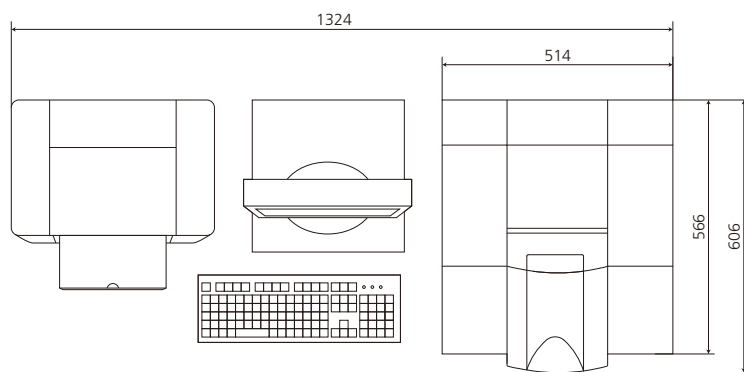

Unit: mm



Software (Labsolutions IR)

OS	Microsoft Windows 7 Professional 32bit edition
Interface	USB 2.0
Programs	Postrun, Spectrum, Quantitation, Photometric, Time course (option), Mapping (option)
Measurement	Spectrum measurement, continuous measurement, atmospheric correction measurement, continuous measurement using ASC, simple measurement mode
Hardware monitor	Self-diagnosis function, status monitor
Manipulation functions	Four Arithmetic Operations, Normalize, Zero Baseline Correction, 3 Point Baseline Correction, Multipoint Baseline Correction, Smoothing, Derivative, Cut, Connect, Reduce, Interpolate, Frequency Convert, X Adjust, Time-Temperature Conversion, Peak Pick, Film Thickness, Data Calculation, Purity, Deconvolution, FFT, Kubelka-Munk, ATR Correction, Kramers-Kronig, Atmosphere Correction, 3D Reprocess, 3D Extract, Purity Judgement
Manipulation functions (option)	Peak split, 3D recalculation, spectrum extraction from 3D data
Analysis support programs	Contaminant (patent pending), Pharma Report, Food Additives Identification
Search functions	Spectrum search (based on similarity), peak search, text search, combination search, setting of search conditions, search of user library and commercial library, creation of user library Library of approx. 12,000 spectra of organic compounds, polymers, pharmaceutical products, inorganic compounds, food additives, contaminants, etc. included
Quantitative functions	Multi-point calibration curve method, CLS quantitative method, PLS quantitative method (option), Photometrics, Recalculation function for quantitative and photometric results
Printing functions	Report template creation, Printing using report templates, Easy printing using the ViewPrint function (patent pending)
Validation program	Complies with Chinese, European, US, and Japanese Pharmacopoeias and ASTM
GLP/GMP support	Tree-structured audit trail function, Recording of operation logs and data logs (history), Saving by overwriting the same filename is prohibited
Security functions	Coordination with LabSolutions security functions, User-group based privilege settings
Macro functions	Easy Macro function <ul style="list-style-type: none"> Collective execution of multiple operations by simply arranging operations in the order of the procedure Execution possible from the desktop Macro platform (option)
Optional software	Rapid scan, Time course software, Mapping program, PLS Quantitation program, Curve-Fitting program, 3D processing program, Macro platform, CLASS-Agent Connection kit.
File formats	Files of JCAMP-DX, ASCII, CSV, IRsolution, HYPER-IR can be loaded and saved.

Computer / Printer

Type	Desktop or laptop
Specifications	Provide a computer and printer of a type recommended by Shimadzu. Enquire separately for detailed specifications.

Other Specifications

Installation site	Temperature: 15°C to 30°C; humidity regulated by air-conditioning equipment Humidity: 70% max.; with no condensation When analyzing or using organic solvents, provide local ventilation systems as required by the applicable laws and regulations.
Power requirements	100/120/220/230/240 VAC, 50/60 Hz, 150 VA for operation, 4 VA for standby * An additional power supply is required for the computer set.

Microsoft and Windows are registered trademarks of Microsoft Corporation in the U.S.A. and other countries.
Other company names or product names that appear in this document are trademarks or registered trademarks of their respective companies.



Shimadzu Corporation
www.shimadzu.com/an/

Company names, product/service names and logos used in this publication are trademarks and trade names of Shimadzu Corporation or its affiliates, whether or not they are used with trademark symbol "TM" or "®". Third-party trademarks and trade names may be used in this publication to refer to either the entities or their products/services. Shimadzu disclaims any proprietary interest in trademarks and trade names other than its own.

For Research Use Only. Not for use in diagnostic procedures.
The contents of this publication are provided to you "as is" without warranty of any kind, and are subject to change without notice. Shimadzu does not assume any responsibility or liability for any damage, whether direct or indirect, relating to the use of this publication.