

**Instruction Manual
For
Medium-Sized Electronic Balance**

**BX-K series
BX32KS, BX52KS, BX12KH, BX22KH, BX32KH**

**BW-K series
BW32KS, BW52KS, BW12KH, BW22KH, BW32KH**

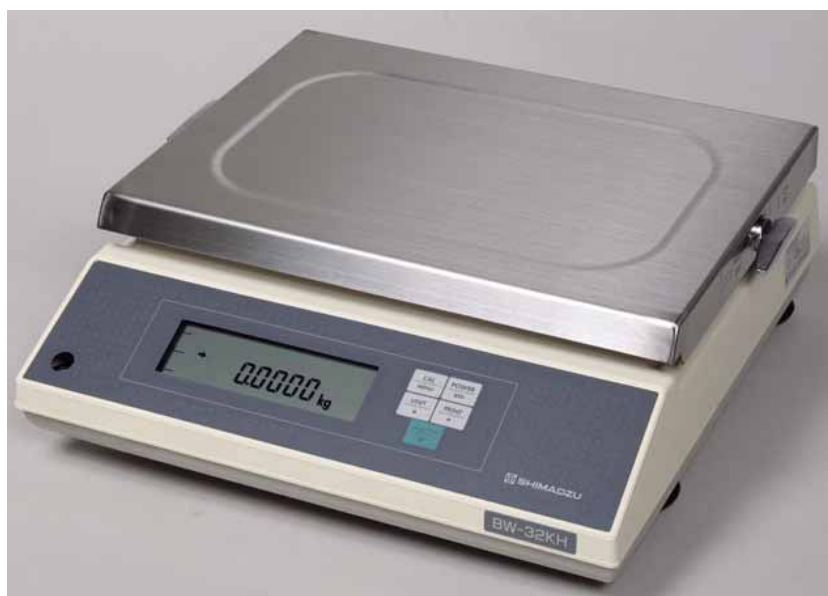

**SHIMADZU CORPORATION
Kyoto, JAPAN**

Notation Conventions





This instruction manual uses the following notation conventions to indicate Safety Precautions.

CAUTION

Indicates a potentially hazardous situation that may result in injury to personnel or equipment damage.

Note: Provides additional information needed to properly use the balance.

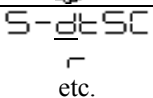
Other conventions used in this manual include:

ITEM	DESCRIPTION
1) 2) 3)...	Indicates the step number in a procedure or a sequence of changes in the balance display.
	Indicates the display change or action sequence performed by the balance after an operation has been initiated.
	Refer to the recommended sections for further information on a specific topic.
 etc.	Indicates the balance display status. Underlined portions (<u> </u>) indicate that the character is blinking.
mass display	Indicates the balance is in the weighing mode and mass is displayed in one of the weighing units.
	These sections include information to make using the balance more convenient.
Menu Map item [1]	Indicates the Menu Map item to be selected. The number inside the [] is the number of the item on the Menu Map.  See Section 2.3 "Menu Map."

SAFETY PRECAUTIONS









To ensure safe and proper operation of the balance, observe the following precautions.

- Do not use the balance in hazardous areas.
This includes areas where the balance is exposed to dust or flammable gases and liquids.
- Use the AC adapter specified by Shimadzu.
To prevent electric shock, never disassemble the AC adapter.

The AC adapter is designed for indoor use. Do not use the AC adapter in exterior environments or where it may be splashed by water.

Ensure that the power supply voltage meets the indicated range of the AC adapter.
- Handle the balance carefully.
The balance is a precision instrument of solid design.
- Do not connect peripheral devices other than those recommended by Shimadzu.
The balance may not operate properly if peripheral devices other than those specified in this manual are used. The specifications for the RS-232C/AUX connector are described in Section 3.2 "Personal Computer - RS-232C". Connect the peripheral devices according to the methods described in this instruction manual.
- DO NOT disassemble the balance, accessories, or peripheral unit.

1.	BASIC OPERATION.....	7
1.1	Balance Components.....	7
	1.1.1 Operations of the Keys on the Main Unit.....	9
	1.1.2 Symbol Display.....	10
1.2	Installation.....	11
	1.2.1 Choosing the Installation Site.....	11
	1.2.2 Balance Installation.....	11
1.3	Turning the Power ON.....	13
1.4	Adjusting the Built-in Clock.....	14
1.5	Span Calibration.....	14
1.6	Weighing.....	14
	1.6.1 Changing the Unit Display.....	15
	1.6.2 Changing the Minimum Display Digit ($10d / 1d$).....	15
1.7	Maintaining and Transporting the Balance.....	15
	1.7.1 Cleaning the Balance.....	15
	1.7.2 Transporting the Balance.....	15
1.8	Specifications.....	16
2	MEMU ITEM SELECTION.....	17
2.1	Introduction.....	17
2.2	Procedure of Menu Item Selection.....	17
2.3	Menu Map.....	19
2.4	General Menu Operations.....	27
	2.4.1 Setting Numeric Values.....	27
	2.4.2 Setting a Decimal Point.....	27
	2.4.3 Menu Lock.....	27
	2.4.4 Last Menu Recall.....	28
	2.4.5 Returning to the Default Settings (menu reset).....	28
2.5	Calibration Execution Menu.....	30
	2.5.1 Calibration.....	30
	2.5.2 Span Calibration Using the Built-in Weight. $1-CAL$	30
	2.5.3 Calibration Check Using the Built-in Weight $1-TEST$	31
	2.5.4 Span Calibration Using External Weights $E-CAL$	32
	2.5.5 Calibration Check Using External Weights $E-TEST$	33
2.6	Calibration Setting Menu.....	33
	2.6.1 Selecting the Standard Calibration Type (\blacksquare - $1-ETARP$).....	33
	2.6.2 PCAL - Calibration of the Built-in Weight \blacksquare - $1-ETARP$	34
2.7	Graphic Display Menu \blacksquare Std : ERUS.....	35
	2.7.1 Overview.....	35
	2.7.2 Full Scale Mode \blacksquare - $FtCLno$	35
	2.7.3 Target Mode \blacksquare - $FtCLno$	35
	2.7.4 Group Mode \blacksquare - $FtCLno$	36

	2.7.5 Level Mode ■ -FtCLno	36
	2.7.6 No Graphic Display ■ -FtCLno.....	36
2.8	Environment Menu ■ Std : ERUS	37
	2.8.1 Overview.....	37
	2.8.2 Averaging E -AbtPB	37
	2.8.3 Stability Detection Band E -AbtPB	37
	2.8.4 Tracking E -AbtPB	38
	2.8.5 Pretaring Value  E -AbtPB	38
	2.8.6 Whole Lighting Mode E -AbtPB	39
	2.8.7 Taring/Printing  E -AbtPB	39
2.9	Application Menu Std : ERUS.....	41
	2.9.1 Overview.....	41
	2.9.2 Zero Range	41
	2.9.3 Auto Zero.....	42
	2.9.4 Auto Print	42
	2.9.5 Peak Hold.....	43
	2.9.6 Interval Timer	44
	2.9.7 Auto-Memory and Zeroing	45
	2.9.8 Animal Weighing	46
2.10.	Unit Registration Menu and Unit Change	47
	2.10.1 Unit Registration Menu	47
	2.10.2 % Conversion	47
	2.10.3 Piece Counting	48
	2.10.4 Solid Specific Gravity Measurement.....	49
	2.10.5 Liquid Specific Gravity Measurement	50
2.11	System Setting Menu ■ Std : ERUS	51
	2.11.1 Date for the Built-in Clock.....	51
	2.11.2 Time for the Built-in Clock S -dtSCR	51
	2.11.3 Display During Standby S -dtSCR	51
	2.11.4 Measurement Control System S -dtSCR	52
2.12	Communication Menu Std ERUS ()	52
	2.12.1 Overview.....	52
	2.12.2 Handshaking  -HFbPSd.....	53
	2.12.3 Format  -HFbPSd.....	53
	2.12.4 Communication Speed  -HFbPSd.....	54
	2.12.5 Parity / Bit Length  -HFbPSd.....	54
	2.12.6 Stop Bit  -HFbPSd.....	54
	2.12.7 Delimiter  -HFbPSd.....	54
3.	Connecting Peripheral Instruments.....	55
3.1	EP-60A Electronic Printer.....	55
3.2	Personal Computer - RS-232C -	55
	3.2.1 Connecting the Cable.....	55

	3.2.2 Data Format	56
	3.2.3 Using Command Codes.....	57
	3.2.4 Windows® Direct Function.....	63
	3.2.5 Multi-Connection Mode.....	65
3.3	Optional AKB-301 Application Keyboard.....	67
	3.3.1 Basic Information.....	69
	3.3.2 Example of Use.....	70
3.4	Foot Switches	72
3.5	Hook for Below-Balance Weighing.....	73
4.	APPENDIX	74
4.1	Part List.....	74
	4.1.1 Standard Accessories and Maintenance Parts	74
	4.1.2 Options.....	74
4.2	Table of Unit Conversion Constants.....	75
4.3	Specifications for the RS-232C/AUX Connector	75
4.4	Error Display List.....	77
	4.4.1 General Display.....	77
	4.4.2 Error Display	77

INTRODUCTION

Thank you for purchasing this medium-sized electronic balance, the Shimadzu BX-K/ BW-K series. In addition to its ability to make rapid mass measurements, the BX-K/ BW-K series is also well-equipped with a four-mode analog display, clock function, various application measurement functions and a unit conversion function. Furthermore, it is a high performance, multi-functional balance which can be used in a great variety of applications when connected to peripherals. The BW-K series features a built-in calibration weight which allows easy sensitivity calibration wherever you are, making it even more convenient to use.

Before using the balance read this instruction manual carefully to ensure long and fruitful use of the BX-K/ BW-K series.







1. BASIC OPERATION

1.1 Balance Components

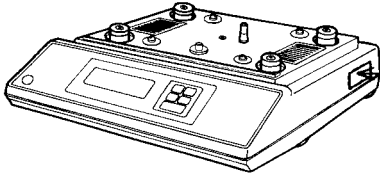
Open the package and sure following items are included.

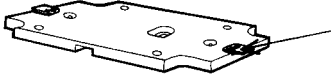
Balance body, pan, AC adaptor, Balance cover, adhesive tape,
Instruction manual, inspection certificate,
<BW-K only>

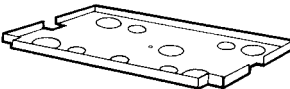
Internal weight, Fix screw of the internal weight, cover of the internal weight
Fix of the screw of the internal cover

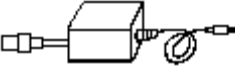
[Name]	[Appearance]	[Notes]
Balance unit		The serial number of the balance is stated on this nameplate
Pan		
Built-in calibration mass		Check that the numerals on this part are the same as the last 5 figures of the serial number on the balance unit (3WK series only)
Calibration weight stopper screw		(3WK series only)
Calibration weight cover		(3WK series only)
Calibration weight cover setscrew		(3WK series only)
AC adaptor		

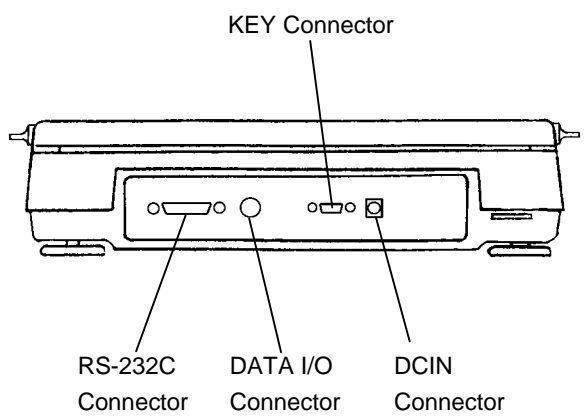
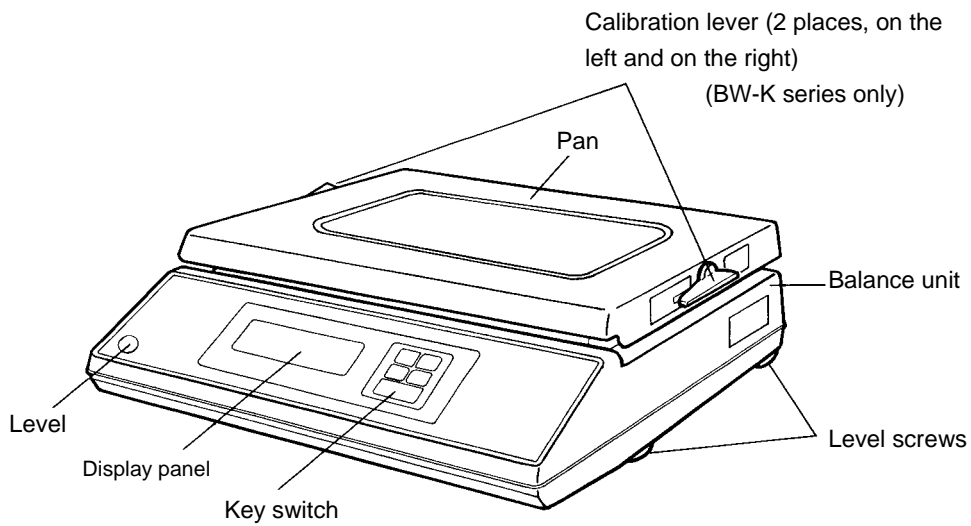

Position of the calibration lever (BW-K series only)

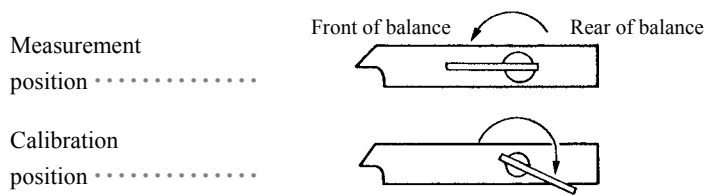

Regardless of whether the calibration lever is in the measurement or calibration position, ensure that both the left and right levers have been turned until they come to a stop.

1.1.1 Operations of the Keys on the Main Unit

The functions of the keys found on the front of the balance are described in the table below.

Key	During Weighing		During Menu Selection (* 1)	
	Pressing Once and Releasing	Pressing and Holding for About 3 Seconds	Pressing Once and Releasing	Pressing and Holding for About 3 Seconds
	Switches between the operation and standby modes.	Exits the Application Measurement function.	Returns to the previous menu.	Returns to the mass display.
	Enters span calibration or menu selection. (*2)	Displays the last Menu Map item that was set. (Last menu recall)	Moves to the next Menu Map item.	Displays the last Menu Map item that was set. (Last menu recall)
	Tares the balance. (Displays zero.) (*3)	Displays the Pretare value.	Selects and sets the currently displayed Menu Map item.	No operation.
	Changes the selected unit. (*4)	Switches between the 1d and 10d display. (*5)	Increases the numeric value of the blinking digit by 1.	No operation.
	Sends the displayed value to a peripheral device.	Sends the date and time to a peripheral device.	Moves to the next digit during numeric value entry.	No operation.

*1 Refer to Section 2. "MENU SELECTION."

*2 This key is used to set values when percent (%), number (PCS), solid specific gravity (d), or liquid specific gravity (d) units are displayed.

*3 When a Pretare value is set, zero is not displayed and the [- Pretare value] is displayed.

*4 Units other than "kg" must be registered and set before they can be used for measurement. Kirogram (kg) is the only unit is registered before shipment. To register other units, refer to Section 2.10. "REGISTRATION, RELEASE, AND SELECTION OF MEASUREMENT UNITS".

*5 When the unit is set to 10d, the resolution of the minimum display is decreased by one decimal place.

1.1.2 Symbol Display

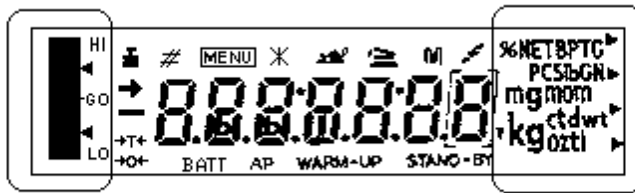

Graphic display

Unit display

An example of “whole lighting” display.

Display	Name	Description
	Stability symbol	Indicates that the balance is stable. (*1)
	Tare symbol	Indicates that a Pretare value has been set.
	Zero symbol	Indicates that Auto Zero is ON for the Application Measurement function.
	Weight symbol	Blinks when span calibration is necessary. This symbol continues to blink until either a manual or automatic span calibration has been made.
	Number symbol	Indicates numeric value entry.
	Menu symbol	Indicates that the menu lock is on.
*	Asterisk	Indicates that the displayed numeric value is not a mass value.
	Animal symbol	Illuminates when Animal Weighing is ON for the Application Measurement function.
	Auto-Memory & Zeroing symbol	Illuminates when Auto-Memory and Zeroing are ON for the Application Measurement function.
	Memory symbol	Indicates that Net Total Weighing is ON for the Application Measurement function.
	Communication symbol	Illuminates during communication to external equipment through the RS-232C or DATA I/O connector.
BATT	Battery symbol	When the balance is operated with the optional battery pack, this symbol illuminates to indicate that the battery voltage has dropped.
AP	Auto Print symbol	Indicates that Auto Print is ON for the Application Measurement function.
STAND-BY	Stand-by symbol	Illuminates when the balance power is in the standby mode. This symbol also illuminates when the Application Measurement function has entered the standby mode.
	Inverse triangle symbol	Illuminates when the solid specific gravity unit is used. This symbol is also used as a substitute for the decimal point.

*1 Stability symbol

The displayed value may change while the stability symbol remains illuminated if the load is changing slowly or if the stability detection band has been set to a large value.

1.2 Installation

1.2.1 Choosing the Installation Site

(1) Power supply

CAUTION

- Select an installation site that is near a power source to ensure that the attached AC adapter is used properly. If this is not possible, an optional battery pack is available as a special accessory.
- Verify that the supply power voltage conforms to that indicated on the AC adapter.

(2) Installation site

CAUTION

Choose an installation site where the balance will be protected from the following:

- corrosive or flammable gasses.
- dust, wind, vibration, electromagnetic waves, or magnetic fields.
- direct sunlight.
- extreme temperature or humidity.
- rain or the possibility of being splashed with water.

Large capacity balances should be installed on a sturdy floor and table that can withstand the total load of the balance AND object to be weighed.

1.2.2 Balance Installation

- 1) Put the balance onto its side and unscrew the 2 transportation screws in accordance with the instruction label on the bottom of the balance. Screw these into the “Release” hole.

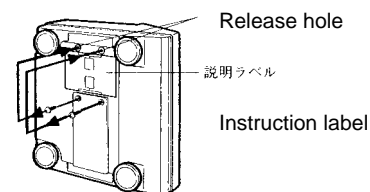

- 2) Place the balance unit as shown in the diagram on the right. If intending to fit the vinyl cover, fix it at this

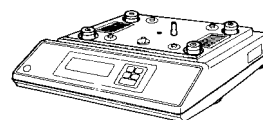

stage of the procedure. Refer to “Fitting the Vinyl Cover”, mentioned later.

- 3) Fix the calibration weight cover (1) with the calibration mass cover setscrew (2).

Note

Steps (3) to (5) are only required with the BW-K series.

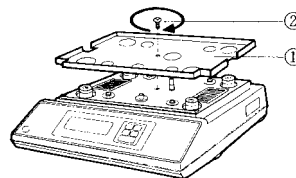

- 4) Put the built-in calibration weight (3) in place and tighten the calibration weight stopper screw (4).

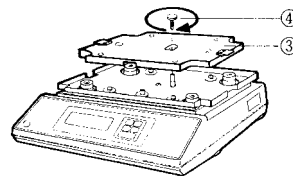

- 5) Turn both the left and right calibration levers of the pan to the **Measurement** position.

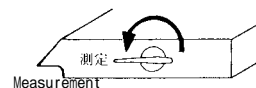

- 6) Place the pan on the balance. For the BW-K series, the pan will be easier to place if it is placed slightly from the rear.

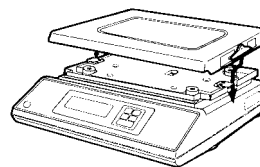

- 7) The level of the balance is adjusted ^{Note}.

Turn the level screws to adjust it so that the air bubble in the level rests inside the red circle. Check that the balance is steady when adjustment is complete.

Note

Adjusting the level can be done with ease if all 4 level screws are at first grounded equally. Next, adjust the front and the back using the 2 front feet, and then adjust left and right using either of the 2 feet on the left and right.

1.2.2.1 Fitting the Vinyl Cover

When using the balance in a location where it is likely to get dirty easily, refer to the diagram below and affix a vinyl cover by following the procedure below. Remove the pan first if fitting the vinyl cover after the balance has been assembled.

- 1) Cut the supplied tape (2) and stick it onto the 4 points on the case (3) (refer to the diagram below).
- 2) Fix the vinyl cover (1) onto the double-sided tape (2), ensuring that there are no creases.

- 3) Fit the pan.
- 4) Place a weight onto the pan which is close to the weighing capacity to check that the pan and vinyl cover are not touching. Accurate measurements cannot be made if there is contact between the two items. If this is the case, re-fix the vinyl cover.

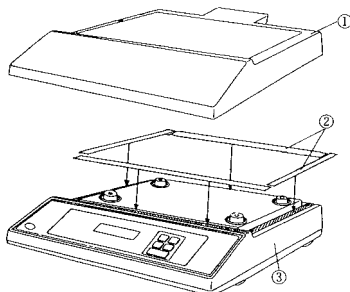

(Note) The vinyl cover (1) is folded up when it is in the packaging.

1.3 Turning the Power ON

- 1) Insert the plug of the AC adapter into the DC IN connector on the rear of the balance, then insert the AC adapter into the power source.
Note: When using the optional battery pack (special accessory), connect the fully charged battery pack to the DC IN connector of the balance using the cable attached to the battery pack.
- 2) The balance self-check is activated and the following messages are displayed in the order indicated.

```

Ver. No. [      ]
HELLO  ─▶ CHE 5 ─▶ CHE 4 ─▶ CHE 3 ─▶
CHE 2
─▶ CHE 1 ─▶ CHE 0 ─▶ Whole lighting ─▶ OFF
(CHE 5 and CHE 4 are not displayed for the BX series.)

```



- 3) When the key is pressed, the whole display illuminates and then the display changes to indicate the kilogram-display.

Note

If ENVIRONMENT menu E8-STOP has been selected, the display stops in the whole lighting state. In this case, press the key during whole lighting to change the display to the kilogram-display.

1.4 Adjusting the Built-in Clock

The BX-K and BX series of balances have a built-in battery driven clock. After unpacking and installing the balance, adjust this clock to the appropriate date and time.



-  Refer to Section 2.11.1 “Date for the Built in Clock.”
-  Refer to Section 2.11.2 “Time for the Built-in Clock.”

1.5 Span Calibration

It is necessary to calibrate the balance after it is moved, or when the ambient temperature has changed.

Verify that the balance is stable before performing the span calibration. To achieve a very stable state, ensure that the balance has been turned on for at least one hour, that the temperature is constant, that there are no breezes or vibrations and that the balance is in an area isolated from the normal traffic flow.

Refer to the following sections for more information on the Span Calibration procedure.

-  For **BX-K series** balances, refer to Section 2.5.2 “Span Calibration Using the Built-in Weight.”
-  For **BX series** balances refer to Section 2.5.4 “Span Calibration Using External Weights.”

1.6 Weighing







- 1) Place the weigh vessel (tare) on the pan.
- 2) Press the  key to zero the display.

Note

If a Pretare value is set, the  symbol is illuminated and zeroing of the display does not occur.

- 3) Place the object to be weighed on the pan, and read the displayed value after the stability symbol is displayed.

Errors Displayed During Weighing

	<i>Overload:</i> Weighing capacity has been exceeded.
	<i>Negative Overload:</i> The load on the balance is too light. The pan is not adjusted properly.
	<i>Display Overload:</i> This display appears if the mass display exceeds 7 digits due to the choice of unit. May appear after the  key is pressed while the solid specific gravity () or liquid specific gravity () units are used.

1.6.1 Changing the Unit Display





Every time the  key is pressed, the unit display changes sequentially among those registered in the UNIT REGISTRATION menu.

Note: Before a unit can be displayed it must be registered in the UNIT REGISTRATION menu. Refer to “2.10 Unit Registration Menu and Unit Change” for information on how to register units.

The unit is displayed sequentially according to the order of the UNIT REGISTRATION menu.

1.6.2 Changing the Minimum Display Digit (/)

It is possible to decrease the resolution of the minimum balance display by one decimal place if necessary.

- 1) Press and hold the  key for approximately three seconds. -  - is displayed and the display is decreased by one decimal place.
- 2) Press and hold the  key for approximately three seconds. -  - is displayed and the display returns to the original number of decimal places.

1.7 Maintaining and Transporting the Balance

1.7.1 Cleaning the Balance

Use a soft damp cloth containing a neutral detergent to clean the balance.

Avoid using organic solvents, chemicals, or dusting sprays as they may damage the coatings of the balance or the display panel.

Attach the in-use balance cover (standard accessory) when the balance is used in an environment where it is susceptible to being soiled.

The pan can be removed and washed with water. Verify that the pan is completely dry before replacing it on the balance.

1.7.2 Transporting the Balance

To carry the balance, hold the balance firmly with both hands.

To transport the balance, use the shipping carton used to deliver the balance.

Before placing the balance into the shipping carton, verify that the transportation screws at the bottom of the balance have been tightened until they stop.

1.8 Specifications

Type	Weighing Capacity (kg)	Minimum Display (g)	Standard Deviation ()g	Linearity \pm g	Range of the External Calibration Weight (kg)
BX32KS BW32KS	32	1	0.6	1	30
BX52KS BW52KS	52	1	0.6	1	50
BX12KH BW12KH	12	0.1	0.1	0.2	10
BX22KH BW22KH	22	0.1	0.1	0.2	20
BX32KH BW32KH	32	0.1	0.12	0.2	30

The BX-K series is not equipped with a built-in calibration weight.

The BW-K series is equipped with a built-in calibration weight.

Temperature coefficient of sensitivity:

H-type = \pm 4ppm/ $^{\circ}$ C

S-type = \pm 5ppm/ $^{\circ}$ C (Range of temperature compensation: 10 to 30 $^{\circ}$ C)

Common Specifications

	BW-K	BX-K
Pan size (mm)	Approx.345 W x 250 D	
Dimensions	Approx.360 W x 355 D x 125 H	
Weight (kg)	Approx.16.5kg	Approx 10.5kg
Operating Temperature Range	5 - 40	
Power Supply	AC adapter (AC100V) or battery pack (special accessory)	
I/O Connector	RS-232C connector DATA I/O connector KEY connector	for RS-232C for Electronic Printer, Printer for application keyboard AKB-301

2 MENU ITEM SELECTION

2.1 Introduction







The BX-W and BW-K series balance has many functions that can be selected to meet the requirements of the user. Menu Item selection is used to program these functions.

The  symbol is displayed during Menu Item selection.

Once the menu items have been set based on the installation environment and weighing purpose, it is not necessary to select the menu items each time the balance is used. Once the contents of the menu are set, they are stored even if the balance is turned OFF or if the power is disconnected.

2.2 Procedure of Menu Item Selection

The menu of the BX-W / BW-K balance consists of four levels.

- 1) Press the  key to cycle through the items within a menu level.
( in the table below)
- 2) Press the  key to choose the current item or move to the next menu level.
( in the table below)
- 3) Press the  key to move back one menu level.
- 4) Press and hold the  key to return to the mass display.







This instruction manual identifies each menu item by a number. For example, , “Anti-Vibration mode” is identified as [25].

 Refer to Section 2.3 "Menu Map" or the attached operation explanatory sheet.



Symbols in the Std : EAUS Display

Press the  key when the following symbols are blinking to enter the associated menu.

- | | |
|---|---|
|  (Calibration) | = Enters the menu related to span calibration. |
|  (Graphic display) | = Enters the menu related to the graphic display, target and checkweighing. |
|  (Environment) | = Enters the menu related to the installation environment and general operation of the balance. |
|  (Application) | = Enters the menu related to applications and printing. |
|  (Unit) | = Enters the menu related to unit conversion. |
|  (System) | = Enters the menu related to the system (clock, reports, and passwords). |
|  (Communication) | =Enters the menu related to communication with a computer and software. |

The stability symbol in the Std : EAUS display indicates that EA-Auto , Eb- !, and Et-on are set.

2.3 Menu Map

To enter the Menu Map:

Turn the balance on.

Press the `←` key during mass display.

(This menu CAN NOT be entered from %, PCS, `←`, and `→` displays.)

The selected span calibration type is displayed. The possible displays are:

`←CAL#` (BW only)

`←ESE` (BW only)

`E←CAL#` (BX or BW)

`E←ESE` (BX or BW)

Press the `←` key again to display the first menu level: `Std : ERUS`

Press the `←` key repeatedly to cycle through the items or press the `→` key to select the blinking item.

Mass Weighing Display

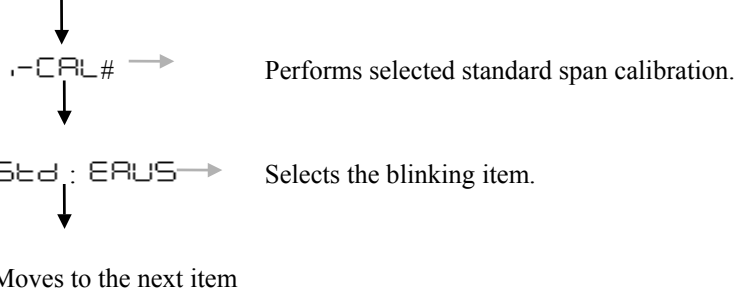

Default settings

Calibration Menu

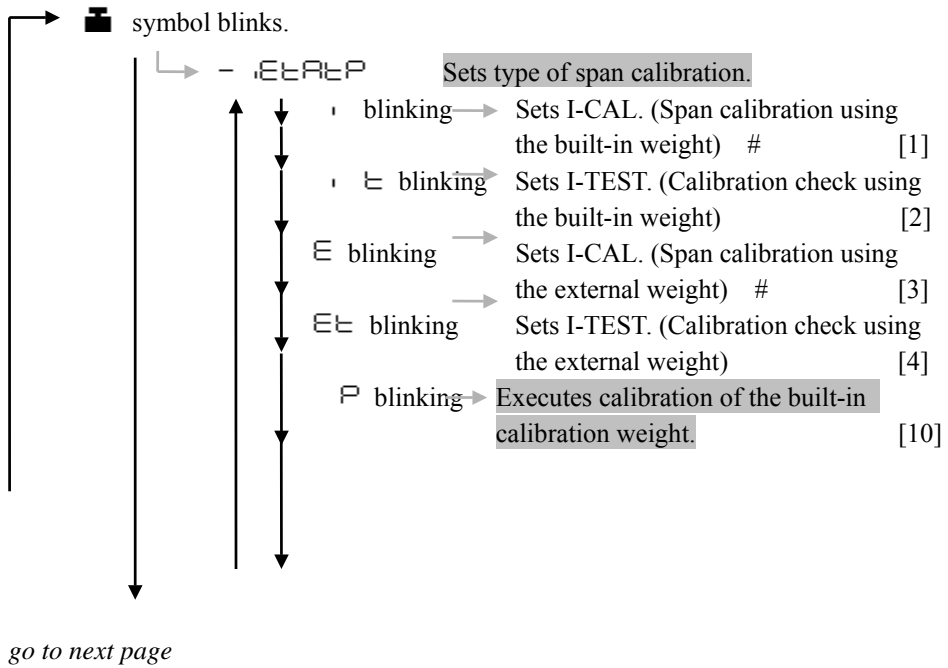

Menu items [3] and [4] are not available on the BX-K series balance.

Default settings

Graphic Display Menu

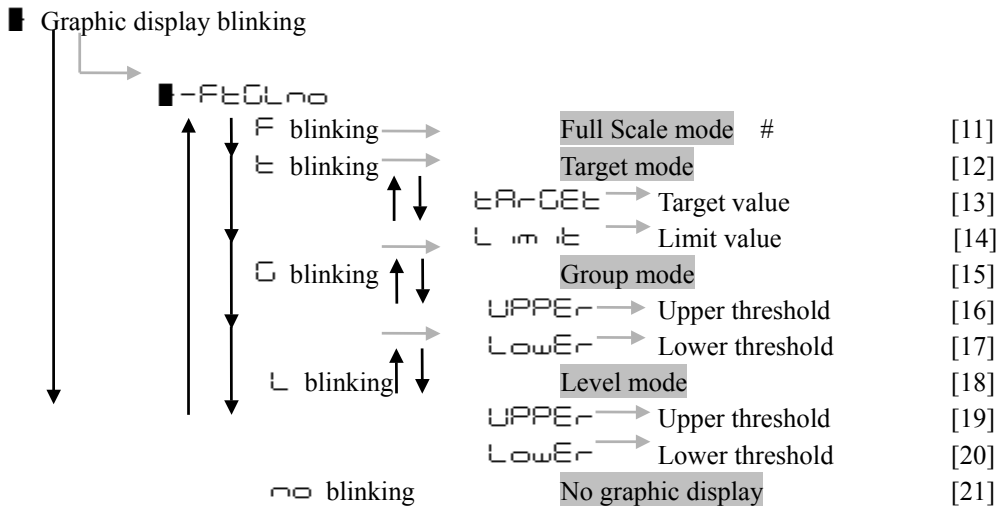

go to next page

Default settings

Environment Menu

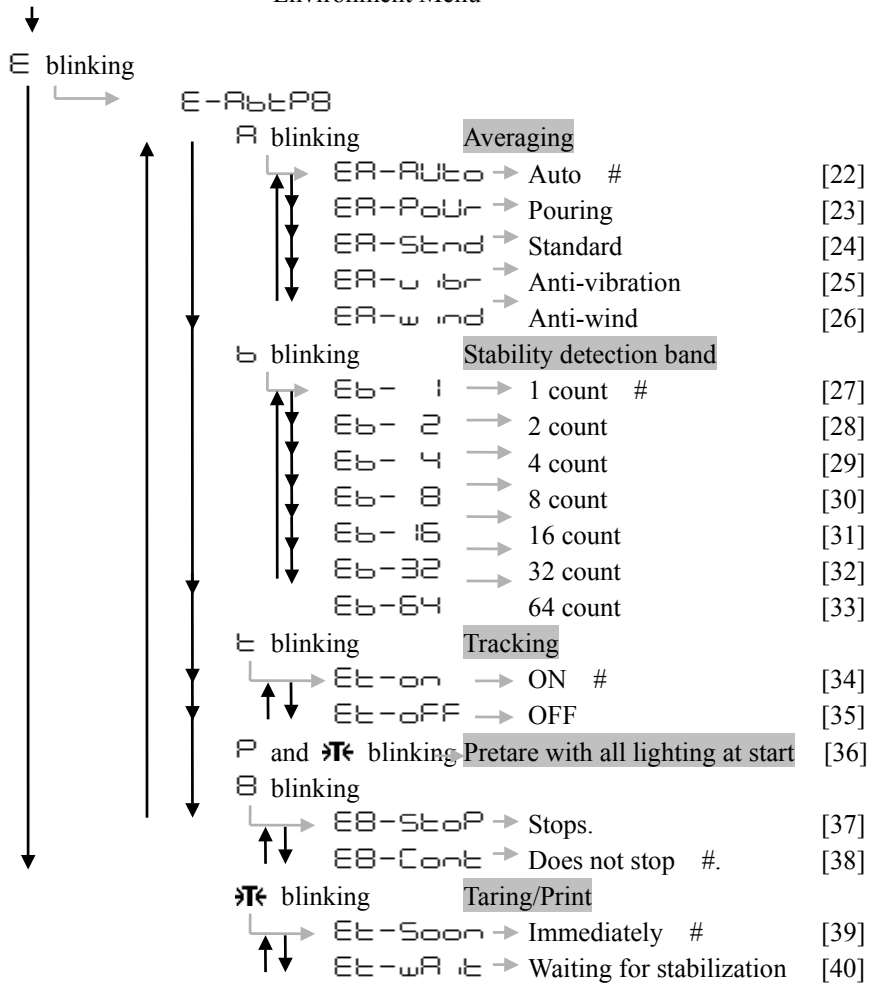

Default settings

Applications Menu

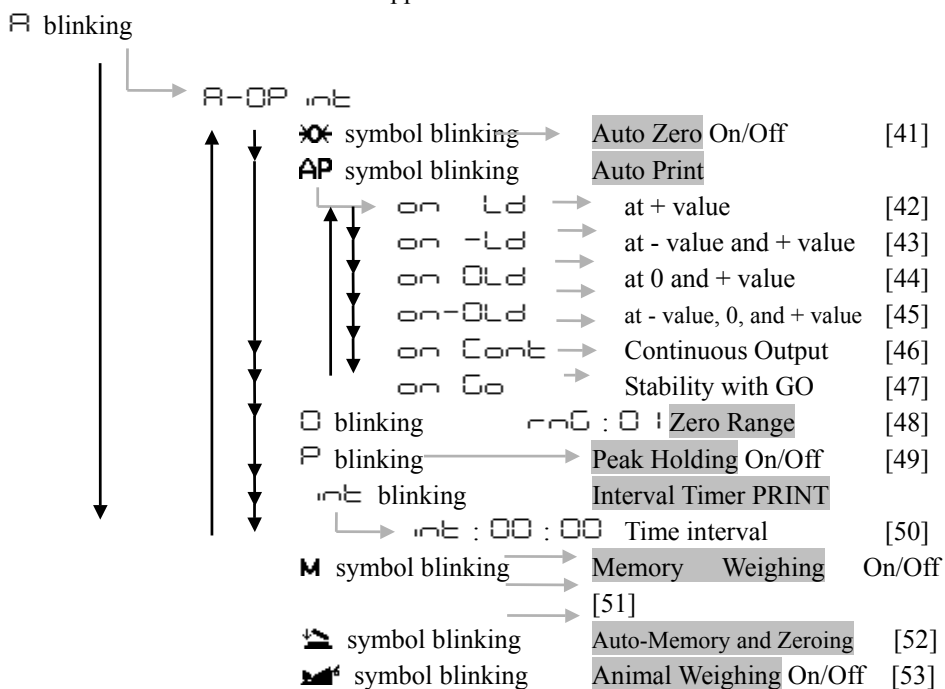

go to next page

Default Setting

Unit Registration Menu

U blinking

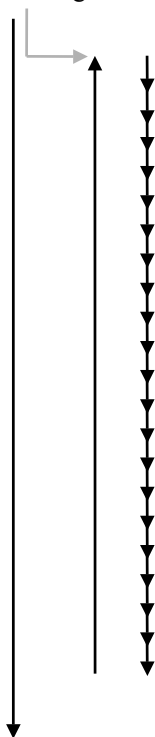

U-g	→	Gram	(g)	[54]
U-mg	→	Miligram	(mg)	[55]
U-%	→	Percent #	(%□)	[56]
U-pcs	→	Number #	(PC)	[57]
U-ct	→	Carat	(CT)	[58]
U-mom	→	Momme	(MO)	[59]
U-□d	→	Immersion liq. density	Solid density(DS)[60]	
U-d	→	Reference wt. volume	Liquid density(DL)[61]	
U-Lb	→	Pound		[61a]
U-Oz	→	Ounce		[61b]
U-Ozt	→	Troy Ounce		[61c]
U-HK	→	Hong Kong's tael		[61d]
U-SPOR-E	→	Singapore tael		[61e]
U-TAIWAN	→	Taiwanese tael		[61f]
U-MAL	→	Malaysia tael		[61g]
U-CHINA	→	Chinese tael		[61h]
U-dwt	→	Pennyweight		[61i]
U-GN	→	Grain		[61j]
U-m	→	Mesghal		[61k]
U-b	→	Bahts		[61l]
U-t	→	Tola		[61m]
U-o	→	Parts Pounds		[61n]
U-USER	→	Set the Multiplier for User unit (US)		[62]

During measurement, these items are distinguished by the position

go to next page

Default settings



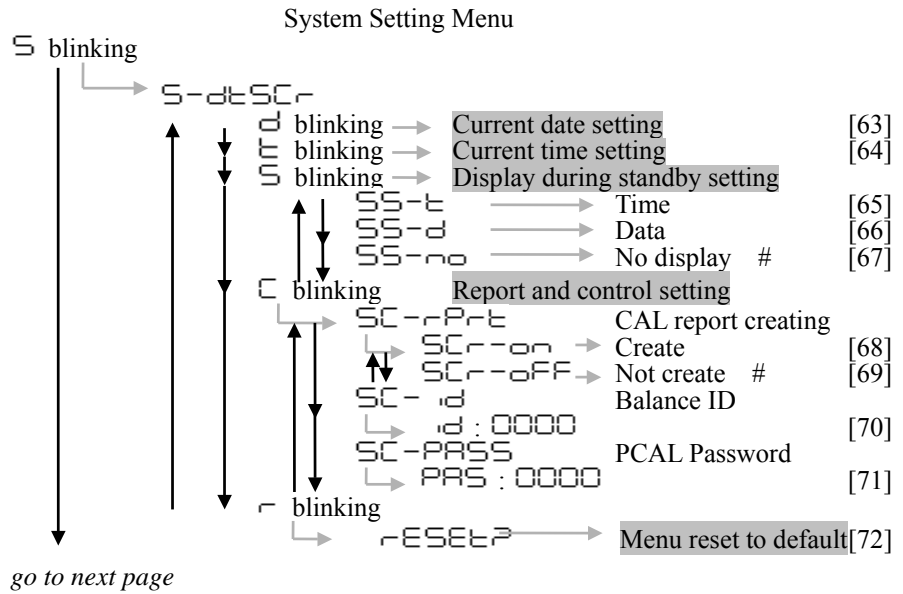

Note:Menu item [71] is not available with the BX-K balances.

Default settings

Communication Settings Menu

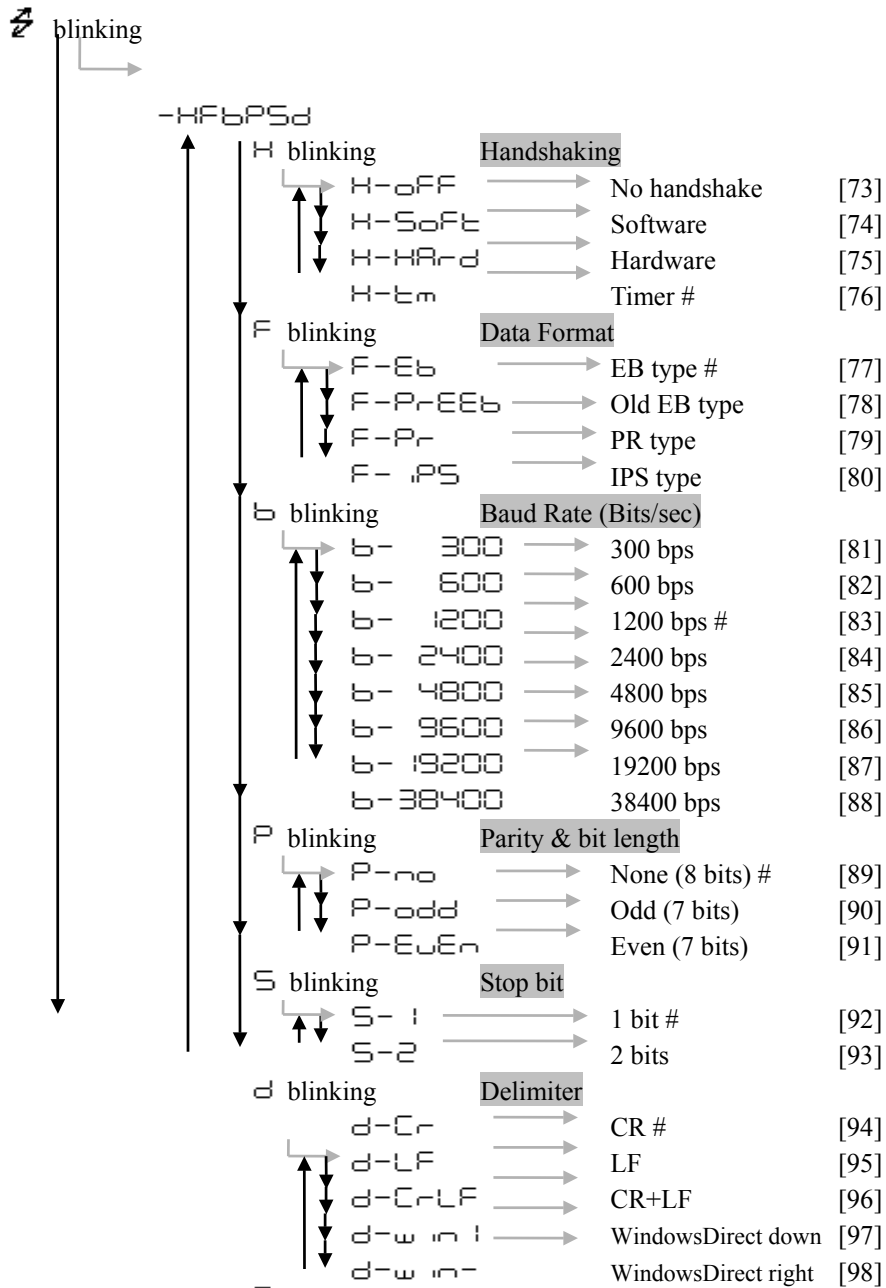

Returns to blinking symbol.

Default settings

2.4 General Menu Operations

2.4.1 Setting Numeric Values

Numeric values may be used to set the threshold of the comparator with the BX-K and BW-K series balances.

Use the optional AKB-301 Application Keyboard to easily set these values. The values may also be set using only the balance keys.

In a menu used to set numeric values, **MENU** and **#** are both illuminated and the digit to be input blinks.

- Press the **▲** key to increase the value of the blinking digit by one. (0...9)
- Press the **▶** key to move the blinking digit one place to the right.
- Press the **SET** key to store the displayed value in the balance memory.
SET is displayed when the value has been successfully saved.
ERR is displayed when the balance failed to save the value.
- Press the **ABORT** key to stop numeric entry. **ABORT** is displayed briefly and the display returns to the menu, one level up.

2.4.2 Setting a Decimal Point

A decimal point is only used when setting units for solid density weighing, liquid density weighing or when setting the multiplier for the user defined unit. Set the decimal point while setting numerical values as follows.

- Press the **▲** key repeatedly until the last digit is blinking. Press the **▼** key once more to initiate decimal point setting mode.
The **▼** symbol or current decimal point blinks.
- Press the **▶** key to move the blinking decimal point one digit at a time to the desired position.
- Press the **SET** key to set the decimal point position.
SET is displayed briefly to indicate that the setting is completed.

2.4.3 Menu Lock

The BX-K and BW-K series of balances have a "Menu Lock" function that locks the menu selections to avoid changes being made by mistake.

The menu lock is toggled ON and OFF by pressing the \square key during OFF display that appears after power is supplied to the balance.

LOCKED is displayed when the menu is locked.

RELEASE is displayed when the menu lock is turned off.

Menu lock is on.

Menu lock is off.

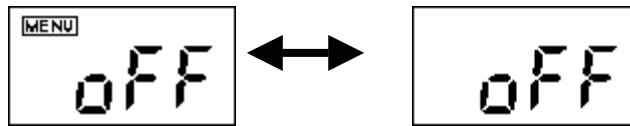

Note: Access is denied and ERR is displayed when the user attempts to select a locked menu.

Use the following procedure to turn off the menu lock function and restore access to the menus.

- 1) Disconnect power from the balance and wait 10 seconds. Reconnect power to the balance.
- 2) When OFF is displayed, press the \square key.
- 3) RELEASE is displayed to indicate that the menu lock has been turned off.

2.4.4 Last Menu Recall

This function is convenient when an application requires frequent changes to a specific Menu Map item.

During mass display or menu selection, press and hold the \square key for approximately three seconds. The last Menu Map item that was changed or set is displayed.

2.4.5 Returning to the Default Settings (menu reset)

The procedure below describes how to reset the menu and return to the default settings. Default settings are indicated with the # symbol in the Menu Map. (See Section 2.3 "Menu Map").

Select Menu Map item [72] to reset the menu.

- 1) In the mass display, press the \square key repeatedly until the S of S-t-d:ERUS blinks.
- 2) Press the \square key.
The system setting menu is selected S-d-t-S-C-R.
- 3) Press the \square key repeatedly until the r in S-d-t-S-C-R is blinking.

- 4) Press the `ESC` key to display `RESET?` ("`?`" means "?").
- 5) Press the `ESC` key again.
`RESET` is displayed to indicate menu reset completion.
- 6) Press the `ESC` key several times (or hold it for approximately 3 seconds) to return to the mass display.

2.5 Calibration Execution Menu

2.5.1 Calibration

Calibration is required to accurately weigh items with an electronic balance. Calibration should be performed:

- When the location of the balance is changed, even within the same room.
- When the room temperature changes considerably.
- Periodically, according to the quality control plan of the user.

Terms used in this manual:

Span Calibration:	Adjustment of the balance to specifications using two weight values; zero and an appropriate value for the balance capacity.
Calibration Check:	Comparing the current calibration mass reading to the calibration mass reading after the last span calibration.
PSC:	Span Calibration is performed automatically using the built-in calibration mass when the balance detects a temperature change that would affect weighing accuracy.
Clock-CAL:	Span Calibration is performed automatically using the built-in calibration mass at up to 3 specific, preset times during each day. The user selects the times.
PCAL:	Procedure to calibrate the built-in calibration mass to an external calibration mass standard. The PCAL procedure is password protected.

Factory Default Settings:

BX-K series	Calibration using the external weight. (E-CAL)
BW-K series	Calibration using built-in weights. (I-CAL)

The settings for the type of calibration can be changed with menu selection.

 Section 2.6.1 "Selecting Standard Calibration Type."

Note: The following displays may appear in the situations listed.

CAL E1	When it takes too much time to stabilize the balance.
CAL E2	When the zero point of the balance appears to have changed greatly.
CAL E5	When the balance calibration appears to have changed greatly or the wrong weight is loaded on the pan during calibration.

In all of these situations, span calibration or calibration check is not performed.

 Refer to Section 4.4.2 "Error Display."

2.5.2 Span Calibration Using the Built-in Weight, I-CAL

- 1) Verify that the balance is in mass display and that the pan is empty.
- 2) Press the  key once, I-CAL is displayed
(If I-CAL is not displayed, return to mass display and select Menu Map item [1].)

- 3) Press the **←CAL** key.
When **←CAL 2** is displayed, and the stability mark () illuminates on the left in the display unit, turn both of the calibration levers on the left and right of the pan to the back until they stop. At this point the stability mark will temporarily disappear.
- 4) Press the **←CAL** key when the stability mark lights up again.
- 5) The display will show **←CAL 1**. Return the calibration levers to the measurement position. The stability mark will disappear temporarily when this is done.
- 6) Press the **←CAL** key after the stability mark lights up again.
After awhile the **SEE** display will appear, and **CALEND** will be displayed. Span Calibration will be complete once the balance goes to kg display.

2.5.3 Calibration Check Using the Built-in Weight **←TEST**

- 1) Verify that the balance is in mass display and that the pan is empty.
- 2) Press the **←TEST** key once, **←TEST** is displayed.
(If **←TEST** is not displayed, return to mass display and select Menu Map item [2].)
- 3) Press the **←TEST** key.
When **←TEST 2** is displayed, and the stability mark () illuminates on the left in the display unit, turn both of the calibration levers on the left and right of the pan to the back until they stop. When this is done the stability mark will disappear temporarily.
- 4) Press the **←TEST** key after the stability mark lights up again.
The display will show **←TEST 1**. Return the calibration levers to the measurement position. The stability mark will disappear temporarily when this is done.
- 5) Press the **←TEST** key after the stability mark lights up again.
After awhile **Δxxx** will be displayed (xxx will be numerals).
This value indicates the extent of the current deviation in the balance sensitivity.
- 6) When correcting the **Δ** value to zero, press the **←TEST** key.
Press the **←TEST** key if not correcting it to zero (although pressing the key will also leave it uncorrected, this will in effect mean “Calibration Aborted”).

Note: Changing the Δ value to zero is equivalent to performing span calibration.

7) $\overline{\text{CAL}}\overline{\text{END}}$ is displayed, indicating the completion of the calibration check.

Note: Examples for interpreting the results of a Calibration Check:

Δ Value	Actual Mass	Displayed Mass
-0.0003	30kg	29.9997 (32kg/0.1g balance)
+0.21	400g	400.21 (420g/0.01g balance)

Error codes that may be displayed:

- Δ $\overline{\text{OVER}}$ indicates that the Δ value is 1000 counts or more.
- Δ $\overline{\text{UNDER}}$ indicates that the Δ value is -1000 counts or less.

2.5.4 Span Calibration Using External Weights $\overline{\text{E-CAL}}$

1) Verify that the balance is in mass display and unload the sample from the pan.

2) Press the $\overline{\text{CAL}}$ key once. $\overline{\text{E-CAL}}$ is displayed.

(If $\overline{\text{E-CAL}}$ is not displayed, return to mass display and select Menu Map item [3].)

3) Press the $\overline{\text{CAL}}$ key.

The value of the correct calibration mass to be loaded is displayed and blinks.



Changing the Calibration Mass to be Used

Pressing the $\overline{\text{CAL}}$ key allows changes to the weight value. Modify the value using the $\overline{\text{CAL}}$ key and $\overline{\text{CAL}}$ key, then press the $\overline{\text{CAL}}$ key. To interrupt modification, press the $\overline{\text{CAL}}$ key.

4) Load the indicated calibration weight and press the $\overline{\text{CAL}}$ key.

5) Shortly, zero display blinks. Unload the weight from the pan and press the $\overline{\text{CAL}}$ key.

$\overline{\text{SET}}$ is displayed briefly to indicate completion of span calibration.

2.5.5 Calibration Check Using External Weights $E - \text{tES} \text{t}$

- 1) Verify that the balance is in mass display and unload the sample from the pan.
- 2) Press the t key once to display $E - \text{tES} \text{t}$.
(If $E - \text{tES} \text{t}$ is not displayed, select Menu Map item [4].)
- 3) Press the t key.

The value of the correct calibration mass to be loaded is displayed and blinks.



Changing the Calibration Mass to be Used

Pressing the t key allows changes to the weight value. Modify the value using the t key and t key, then press the t key. To interrupt modification, press the t key.

- 4) Load the indicated calibration mass and press the t key.

The zero display blinks.

- 5) Unload the weight from the pan and press the t key.

The display changes to the $\text{d}xxx$ display. (xxx indicates a numeric value)

- 6) To change the d value to zero, press the t key.

Press the t key to avoid changing the d value to zero. Pressing the t key interrupts calibration and does not change this value to zero.

Note: Changing the d value to zero is equivalent to performing span calibration.

2.6 Calibration Setting Menu

2.6.1 Selecting the Standard Calibration Type (t - $\text{tES} \text{t}$)

Menu Map item [1]	t blinking	Selects "Span calibration using the built-in weight."
Menu Map item [2]	t blinking	Selects "Calibration check using the built-in weight."
Menu Map item [3]	E blinking	Selects "Span calibration using external weights."

Menu Map item [4] $\text{E} \leftarrow$ blinking Selects "Calibration check using external weights."

2.6.2 PCAL - Calibration of the Built-in Weight - $\text{E} \leftarrow \text{A} \leftarrow \text{P}$

PCAL is used to calibrate the built-in weight to a standard calibration weight that is correctly adjusted, traceable and/or certified.

CAUTION

Use a correctly controlled, precise calibration mass for this procedure. If it is performed without a correct calibration mass, span calibration and calibration checks using the built-in mass may not be correct in subsequent operations.

- 1) Unload the sample from the pan and verify a zero mass display.
- 2) Select the Menu Map item [10].
 $\text{P} \leftarrow \text{A} \leftarrow \text{S} : \square \square \square \square$ is displayed.
- 3) Enter the PCAL password using the and keys, then press the key.

The default password is 9999, set at shipment or upon menu reset.

- 4) After $\text{P} \leftarrow \text{C} \leftarrow \text{A} \leftarrow \text{L} \leftarrow \text{E}$ is displayed, the value of the standard weight to be loaded blinks.
Load the standard mass displayed and press the key.
- 5) Shortly, zero is displayed and blinks. Unload the weight and press the key.
- 6) From this point the display will proceed automatically. When $\text{P} \leftarrow \text{C} \leftarrow \text{A} \leftarrow \text{L} \leftarrow \text{E}$ is displayed, operate the levers on both sides of the pan to put on the built-in calibration weight.
- 7) Press the key when the stability symbol re-illuminates after having disappeared for a moment.
- 8) When $\text{P} \leftarrow \text{C} \leftarrow \text{A} \leftarrow \text{L} \leftarrow \text{E}$ is displayed, operate the levers on both sides of the pan to take off the built-in calibration weight.
- 9) Press the key when the stability symbol re-illuminates after having disappeared for a moment.
- 10) From this point the display will proceed automatically. The procedure is complete when the balance goes to mass display mode.

Note: SET is displayed during the process. Leave the balance in a stable state until the mass display appears as in step 6.

- In PCAL, the value of the "weight to be loaded" cannot be changed.
- Set the PCAL password using Menu Map item [71].

2.7 Graphic Display Menu ■ SET : ERUS

2.7.1 Overview

The BX-K and BW-K series balance has a bar graph located on the left side of the display. This graph can be conveniently used for liquid weighing and pass or failure judgment (comparator function) of the sample.

The graphic display functions include the Full Scale mode, Target mode, Group mode, Level mode, and no graphic display mode.

Note: Target, limit, upper, and lower values are set as numeric values only. Set the correct numeric value for the unit that will be used for weighing.

- In weighing mode, changing the displayed unit does NOT change the target, limit, upper, or lower numeric values. For example, when the upper limit has been set at 10g, switching the unit from "g" to "kg" does not change the limit to 10kg. It will be 0.01kg.
- The decimal point is invisible in the value setting display. Determine its position based on the resolution of the balance. For example, if the balance's minimum display is 0.01g, 150g must be set by inputting "15000" in the display.
- Numeric values are memorized independently for each graphic display mode.
- The graphic display mode can be selected without setting numeric values.

2.7.2 Full Scale Mode ■ -F_uLno

The relative amount of the load on the pan is displayed in the bar graph. This feature helps to prevent errors due to OL (overload) status.

Use Menu Map item [11] to select the Full Scale mode.

A bar displayed in the lower areas of the scale indicates that the load on the pan is small.

A bar displayed in the upper areas of the scale indicates that the load on the pan is close to the weighing capacity.

2.7.3 Target Mode ■ -F_TOLno

Target mode is useful for filling applications or for quality check by weight.

The T_{AR}GET value is the numeric value that is the desired amount in the unit that is used for weighing. The L_{IM}IT value is the numeric amount above or below the target value that is acceptable.

This mode is useful for constant amount weighing of liquid or judgment of excess and shortage.

Menu Map item [12] selects the Target mode.

Menu Map item [13] sets the $UPPER$ value, which corresponds to the center line of the graphic display.

Menu Map item [14] sets the $LIMIT$ value, which corresponds to the distance between the center line and upper or lower triangles.

2.7.4 Group Mode \blacksquare -FtCLno

This is the best mode to determine pass or failure judgment based on the sample weight.

Menu Map item [15] selects the Group mode.

Menu Map item [16] sets the upper threshold value, which corresponds to the upper triangle.

Menu Map item [17] sets the lower threshold value, which corresponds to the lower triangle.

Note: Determination as follows:	<u>Display</u>
$UPPER < \text{Sample weight}$	HI
$LOWER \leq \text{Sample weight} \leq UPPER$	GO
$\text{Sample weight} < LOWER$	LO

2.7.5 Level Mode \blacksquare -FtCLno

Use this mode for classification based on the sample weight. The display looks like a bar graph, but also includes a comparator function.

Menu Map item [18] selects the Level mode.

Menu Map item [19] sets the upper threshold value, which corresponds to the upper triangle.

Menu Map item [20] sets the lower threshold value, which corresponds to the lower triangle.

Note: Determination as follows:	<u>Display</u>
$UPPER < \text{Sample weight}$	HI
$LOWER \leq \text{Sample weight} \leq UPPER$	GO
$\text{Sample weight} < LOWER$	LO

2.7.6 No Graphic Display \blacksquare -FtCLno

Menu Map item [21] turns off the graphic display.

2.8 Environment Menu ■Std : EAUS

2.8.1 Overview

Settings on the balance can be changed to compensate for the installation environment such as the degree of vibration etc. or for the purpose of weighing a solid, liquid or powder.

2.8.2 Averaging E-AbtPB

It is possible to match the stability of the display and the degree of response with the requirements of specific applications.

Menu Map item [22] EA-AUTO (Environment/Averaging-AUTOMATIC)
The balance automatically performs optimum averaging dynamically while observing the load data. This is the recommended setting and should be used unless special circumstances exist.

Menu Map item [23] EA-POUR (Environment/Averaging-POURING)
This mode is only suitable for constant volume weighing of liquids etc. This mode is very sensitive to wind and vibration.

Menu Map item [24] EA-STD (Environment/Averaging-STANDARD)
This mode is suitable for weighing in a normal environment. Averaging is fixed and does not change dynamically as in EA-AUTO.

Menu Map item [25] EA-VIB (Environment/Averaging-VIBRATION)
Use this mode when the balance is used in a location where there are large vibrations and the display fluctuates in the EA-AUTO mode.
Response time is deteriorated by small mass amount changes.

Menu Map item [26] EA-WIND (Environment/Averaging-WIND)
Use this mode when the balance is used in a location where it is exposed to airflow that causes the display to fluctuate in the EA-AUTO mode.
Response time deteriorates further than EA-VIB, but weighing is comparatively stabilized.

Note: If weighing cannot be performed efficiently even with EA-WIND, change the installation site of the balance or use the deluxe windbreak or large pan windbreak.

2.8.3 Stability Detection Band E-AbtPB

Menu items [27] to [33] are used to determine the conditions for indicating balance stability.

EB-1 (Environment/Band-1):

When the display has remained constant (within one display count), the balance is regarded as stable and the stability symbol illuminates. Stability detection band settings can be selected from EB-2 to EB-64.

Note: Use $E\bar{b}-i\bar{S}$ to $E\bar{b}-S\bar{4}$ only when the Auto Print function is used and it is therefore required that the sensitivity to vibration be reduced to allow the balance to be regarded as stable and print the measurement value.

The balance may not operate properly if these settings are selected under normal use conditions and environment.

2.8.4 Tracking $E-A\bar{b}\bar{t}\bar{P}\bar{B}$

Tracking is the function that will maintain the current displayed value as long as possible.

Menu Map item [34] $E\bar{t}-o\bar{n}$ Turns ON this function.

Menu Map item [35] $E\bar{t}-o\bar{F}\bar{F}$ Turns OFF this function.



Zero Tracking Function

When the display is zero, $E\bar{t}-o\bar{n}$ menu functions as "zero tracking" to keep the zero display as long as possible. "Zero tracking" automatically cancels small zero drift.

It is recommended to set to $E\bar{t}-o\bar{F}\bar{F}$ when measuring slight mass change such as in the process of drop addition or liquid evaporation.

2.8.5 Pretaring Value $\bar{t}\bar{r}\bar{k}$ $E-A\bar{b}\bar{t}\bar{P}\bar{B}$

This function is used to weigh the mass of a sample packed in a container such as a bottle or bag without opening the container. Pretare function should be used only if the mass of the containers does not vary from sample to sample. Instead of zero the pretare value is displayed (as a negative value) when the $\bar{t}\bar{r}\bar{k}$ key is pressed. The pretare value is then subtracted from the load on the balance pan to determine the weight of the sample.

- 1) Menu Map item [36] opens the Pretare setting screen.
- 2) Set the Pretare value using the $\bar{t}\bar{r}\bar{k}$ key and $\bar{t}\bar{r}\bar{k}$ key, and press the $\bar{t}\bar{r}\bar{k}$ key.



Pretare Value

Cancel the Pretare value by setting the value to zero.

When a Pretare value other than zero has been set, $\bar{t}\bar{r}\bar{k}$ illuminates.

The Pretare value is set using the "kg" unit. The maximum value is dependant on the weighing capacity of the balance.

Check the Pretare value by pressing and holding the $\bar{t}\bar{r}\bar{k}$ key for approximately 3 seconds during weighing.

To set a pretare value using the optional AKB-301 Application Keyboard, press the [Pretare value] and the key at the same time. Use the AKB-301 if you have to change the Pretare value frequently.

2.8.6 Whole Lighting Mode E-ABtPB

Press the key to switch from the standby mode to the mass display. The entire display is illuminated. This function sets whether the display automatically proceeds to mass display or waits for a key command. When the mode has been set to EB-STOP, it is easier to check the display because the display remains illuminated.

Menu Map item [37] EB-STOP

Display stops at whole lighting. Press the key to proceed to the mass display.

Menu Map item [38] EB-CORt

After the whole lighting display has appeared for approximately 0.5 sec, the display automatically proceeds to the mass display.

2.8.7 Taring/Printing E-ABtPB

Determine if the balance should wait for stability before printing when the key is pressed or displaying the zero point when the key is pressed.

When the Application Measurement function is selected, the key does not wait for stability.

Menu Map item [39] Et-Soon

Print and tare operate without waiting for stabilization.

Menu Map item [40] Et-wR t

Print and tare operate after the stability symbol illuminates.

Note: When the balance is in the Et-wR t mode and waiting for stability to be determined, ---- is displayed when the key is pressed.

Press the key to disable this function. Taring is not executed after the key is pressed.

Once the key is pressed, data is not output until the  and symbol has illuminated and the balance is stable. Data is output only after the stability symbol is lit.

2.9 Application Menu `Set : EAUS`

2.9.1 Overview

The Application Measurement function is the generic name of the functions used to perform measurement work using the balance in more efficient ways. Only one Application Measurement function can be used at a time. When the power is turned ON, the balance will begin in the function mode that was last set.



Cancellation of Application Measurement

To cancel the Application Measurement, press the key while in the mass display and hold it until `APL END` is displayed.

To use the Application Measurement function that was just canceled, use the last menu recall function by pressing and holding the key for 3 seconds in the mass display.



Using the Application Measurement Function with a Unit Other Than "kg"

Select the Application Measurement function while in the mass display, and select the unit of weighing with the key.

Because the operation of the differs from the one in normal mass display, the Application Measurement function cannot be selected while %, PCS, or specific gravity units are displayed.

2.9.2 Zero Range

The "Zero Range" value is used in the Application Measurement function as a reference to identify whether the sample is loaded.

For example, if the display is within the Zero Range, the balance determines that a sample is not loaded. If the display is more than five times the Zero Range it determines that a sample is loaded. Application Measurement functions which involves judgment of whether a sample is loaded or not work in accordance with the Zero Range setting.

In Menu Map item [48], the "Zero Range" value is set using the number of counts displayed in kilogram-display.

The setting range is 01 to 99 with 01 being the default value. Even when weighing will be done in another unit, Zero Range setting is made by only gram value.

Note: When a Pretare value is set, the value to determine that there is "no load" becomes "- Pretare ± Zero Range" during mass display. For example, the Zero Range function works as expected when attempting to weigh and Auto Print the mass of a bottled sample during mass display.

2.9.3 Auto Zero

Select Menu Map item [41].



When the displayed value is within the Zero Range and the stability symbol has illuminated, zeroing occurs automatically. The  symbol appears in the display when the Auto Zero function is active.

Other keys function as expected with the Auto Zero function activated.

2.9.4 Auto Print

Auto Print function allows output of the data automatically without pressing the  key for each sample. The **AP** symbol is illuminated when the Auto Print function is activated.

Six types of Auto Print are possible.

Menu Map item [42]   (on positive load)



Load the sample when the value displayed is within the Zero Range. When the stability symbol has illuminated and the positive displayed value is more than 5 times the Zero Range, data is automatically output.

The next data output is not performed unless the display has returned to a value within the Zero Range by unloading the sample or pressing the  key.

Menu Map item [43]   (on positive or negative load)



Load or unload the sample when the displayed value is within the Zero Range. When the stability symbol has illuminated and the displayed positive or negative value is more than 5 times the Zero Range, data is automatically output.

The next data output is not performed unless the display has returned to a value within the Zero Range by unloading the sample or pressing the  key.

Menu Map item [44]   (on positive load and on zero)

Load the sample when the value displayed is within the Zero Range. When the stability symbol has illuminated and the positive displayed value is more than 5 times the Zero Range, data is automatically output.



Unload the sample or press the  key. When the displayed value is within the Zero Range and the stability symbol has illuminated, data is output again.

Menu Map item [45]   (on positive or negative load and on zero)

Load the sample when the value displayed is within the Zero Range. When the stability symbol has illuminated and the displayed positive or negative value is more than 5 times the Zero Range, data is automatically output.



Unload the sample or press the  key. When the displayed value is within the Zero Range and the stability symbol has illuminated, data is output again.

Menu Map item [46]   (on /continue)

By pressing the  key while the **AP** and **STAND-BY** symbols are lit, the **STAND-BY** symbol goes out, the  symbol lights and the displayed data is continuously output.

Continuous output stops temporarily when the  key is pressed.

Note: During continuous output, the  symbol may appear to remain lit. If the transfer speed of the data output is slow, the display may flash. Increase the transfer speed as much as possible and set the handshake to **H-OFF**.

Menu Map item [47]   (on / go)

When the graphic display is in Comparator mode (Group mode or Level mode) and the stability symbol lights in the GO range, the data is output once. The next data output is executed after the displayed value is within the Zero Range.

2.9.5 Peak Hold

Menu Map item [49] measures the displayed peak value. The **P** symbol is illuminated when the Peak Hold function is activated.

"Peak value" is the highest or lowest stable value displayed after the display has changed beyond five times the Zero Range.

- 1) In the peak detection standby state with the **P** and **STAND-BY** symbols illuminated, press the **ON** key to tare the display.
- 2) Press the **ON** key.
The **STAND-BY** symbol disappears and peak value detection starts.
- 3) **P** and * are simultaneously displayed after the peak value is detected, and the data is output. This display will not change regardless of the load on the pan.
- 4) Press the **ON** key.
The balance returns to the peak detection standby state in step 1).

Note: Press the **ON** key in the peak detection standby state to initiate the power standby state.

Press the **ON** key during detection of the peak to return to the peak detection standby state.

Polarity of the peak value displayed is "polarity of the displayed value of the first change by five times or more of Zero Range from the display within Zero Range."

Usually the peak value is easily measured by setting to **ER-POL** [23]. Depending on the weighting conditions and the sample type, this setting may not always be successful.

2.9.6 Interval Timer



Automatically outputs the displayed value at preset intervals. The **T** symbol is illuminated when the Interval Timer is activated.

The optional AKB-301 Application Keyboard is convenient when the interval is changed frequently.

- 1) Using Menu Map item [50], set the output interval (00:01 = 1 sec to 99:59 = 99 minutes 59 seconds).
- 2) In the interval timer standby state when the **T** and **STAND-BY** symbols are both illuminated, press the **ON** key.
The first data is output. Data is automatically output at the set time intervals.
- 3) To stop output, press the **ON** key.
The balance returns to the interval timer standby state in step 1).

Notes:







- Use the **ON** key to erase the tare or zero the balance at any time.

- Pressing the  key while in the interval timer standby state causes the power supply standby state to be initiated.
- To release the interval timer function, keep pressing the  key. This does not reset the interval timer function to zero.
- Using the interval timer function to record data over a long period may cause data error due to balance drift.
- Some instruments receiving the data may not operate normally if the set time interval is short. To correct this, set the time interval to a longer period. When the set time interval is short and the instrument connected to DATA I/O is unknown, it is recommended to set the handshake to a setting other than H-H-L-M [76].

2.9.7 Auto-Memory and Zeroing

Use Menu Map item [51].

This menu is used to weigh a large number of individual samples. The  (Auto-Memory and Zeroing) symbol is illuminated when this function is active.

- 1) Load the weighing vessel and press the  key in the Auto-Memory and Zeroing standby state ( and **STAND-BY** symbols are lit). Zeroing occurs.
- 2) Press the  key.
The **STAND-BY** symbol disappears, and Auto-Memory and Zeroing measurement starts.
- 3) Load the first sample. Each time the stability symbol is lit and the display is a value five times or more the Zero Range or the  key is pressed, the displayed value is output and zeroing occurs.
- 4) For the next sample, additional weighing is performed without pressing the  key.
- 5) Press the  key.
The balance returns to the Auto-Memory and Zeroing standby state and total mass on the pan without the tare is displayed.
Press the  key to print this value.

Notes:

- When the stability symbol is illuminated and the displayed value is within the Zero Range, zeroing occurs automatically.

- When the key is pressed and the displayed value is five times the Zero Range, zeroing occur after data output. (Manual loading)
- When the key is pressed in the Auto-Memory and Zeroing standby state, the power supply standby state is initiated.

2.9.8 Animal Weighing

Set with Menu Map item [53].

This function is suitable for weighing animals.  (animal) symbol is illuminated when the Animal Weighing mode is active.

- 1) Load the weighing vessel and press the key.

Note: Data may be output when the weighing vessel is loaded. This is not a malfunction.

- 2) Load the sample (animal etc.) with a mass more than 50 times the Zero Range.
- 3) When the weighed value is relatively stable, the value is automatically output.
- 4) Press the key or unload the sample.
- 5) When the displayed value is stable and less than 10 times the Zero Range, automatic zeroing occurs.

Any residue remaining on the pan (excrement or fur) is automatically canceled and zeroing occurs. If zeroing does not occur, increase the value of the Zero Range.

Notes:

- Standby state is not available in the Animal Weighing mode.
- Press the key to initiate the power supply standby state.
- On the premise of weighing animated objects, the stability detection band is automatically extended in the Animal Weighing mode. Reproducibility of the measurement data is slightly less than with other modes.
- When the animal being weighed cannot be controlled and Auto Print will not activate, press the key to output the displayed value. Then unload the animal. Even if the stability symbol lights before the animal is removed, data is not printed again.
- By setting a larger stability detection band in the menu, the stability symbol will light more readily.
- If the balance is slow to return to the zero point set a larger Zero Range value.

2.10. Unit Registration Menu and Unit Change

Std: ERUS

2.10.1 Unit Registration Menu

Press the  key in mass display to sequentially change the registered units. It is possible to display units other than "kg" with the BX-K and BW-K series of balances. Before weighing, set the display units to be used with the unit setting menu [54] to [62]. (Unit kg, %, number (PCS) were set before shipment.)



Note:

- In the unit setting menu, the stability symbol is illuminated to indicate the currently set units.
- Set or release the unit by pressing the  key when the unit is displayed.

Functional Units:

Solid specific gravity unit ( d): Density of the liquid in which the sample is immersed.

Liquid specific gravity unit (d): Volume of the reference weight to be immersed in the sample.

 unit (): Numeric value (multiplier) multiplied by the gram (g) weight of the unit.

To register Functional Units, set the constant to something other than 0. Setting the constant to 0 turns the function off.

For the unit names, refer to  Section 2.3 "Menu Map."

2.10.2 % Conversion

- 1) Set the % unit with Menu Map item [56].
The % unit is set before shipment.
- 2) Press the  key several times in the mass display until the % unit is displayed.

Setting the 100% reference

Press the  key to tare the balance.

Load the reference sample that corresponds to the 100%value. This value must be equivalent to 100 counts or more in the "kg" unit.

When the stability symbol illuminates, press the  key.

 is displayed briefly and the reference sample weight is displayed as 100%.

Note: The numbers of digits displayed in the % unit and rounding off of the minimum digit vary depending on the mass value of the reference sample and the balance model. It is not possible to obtain resolution greater than that in the "g" unit.

The weight of subsequent samples are displayed as a percentage of the reference sample weight.

2.10.3 Piece Counting

- 1) Register the PCS unit with Menu Map item [57].
(The PCS unit is registered before shipment.)
- 2) Press the key several times in the mass display until the PCS unit is displayed.
- 3) Load the container and press the key to tare the balance.
- 4) Count exactly five pieces (or 10, 20, 50, 100, or 200 pieces) of sample to be measured and load them on the pan.
- 5) Press the key.
- 6) Every time the key is pressed, the display sequentially changes as
┌┐ 5pcs ──> ──> ┌┐ 200pcs ──> ┌┐ 5pcs ──> ... (Piece menu).
The default setting is ┌┐ 10 pcs.)

Press the key when the display is equivalent to the number of loaded pieces.

Example: If 50pcs. are loaded, press the key when ┌┐ 50pcs is displayed. This determines the unit weight or average weight per piece.
As sample is added or removed, the piece count (number of pieces) is displayed.

Note: Repeat steps 3 through 6 above when the sample or manufacturing lot is changed.



Piece Count Menu Display a Next Setting

In this example, when the key is pressed in the next PCS menu, display starts from ┌┐ 50pcs.



Counting Pieces Using the Optional AKB-301 Application Keyboard

By using the optional AKB-301 Application Keyboard, piece count based on an arbitrary number of pieces is possible.

The unit weight itself, if it is known, can be input using the numeric keys.

 Section 3.5 "AKB-301 Application Keyboard".

2.10.4 Solid Specific Gravity Measurement

Solid specific gravity measurement refers to the measurement of the sample (solid) weight in the air and in a liquid of known density and the calculation of the sample density.

The ∇d symbol is used to represent the solid density unit in this balance. The data output unit is DS.

1) Set Menu Map item [60].

Note: Enter the value for the density (g/cm^3) of the liquid (water, alcohol etc.) in which the sample is immersed.

2) Attach the optional weighing hook to the bottom of the balance, attach the hanging pan, and then immerse the hanging pan in the tank filled with the liquid of known density.

3) Press the ∇ key until d is displayed.

4) Press the ∇ key.

5) Load the sample on the balance pan or in the hanging pan in air.

6) After the stability symbol illuminates, press the ∇ key.
 ∇d may be displayed but does not indicate a malfunction.

7) Load the sample on the hanging pan immersed in the liquid. The density of the sample is displayed.

8) Repeat steps 4 through 7 for each additional sample.

Note:

- Up to four decimal places are displayed for specific gravity. Since it may not be possible to stabilize the balance using all 4 places, 1d/10d switching is possible.
- When loading the sample on the pan in the liquid, ensure that the entire sample is immersed in the liquid.
- The balance does not re-zero when the ∇ key is pressed in this unit display.
- When the optional Specific Gravity kit is used, refer to the Instructional Manual of the Specific Gravity kit for the procedure.
- Return the balance to kg display mode first before performing the next menu operation.

2.10.5 Liquid Specific Gravity Measurement

Liquid specific gravity measurement refers to the measurement of the weight of a reference solid of a known volume in air and in the sample liquid. Specific gravity for the liquid is calculated from these two values of.

The display unit for liquid specific gravity is "d." The data output unit is DL.

1) Set Menu Map item [61].

Note: Enter the value for the volume (cm³) of the reference weight.

2) Attach the optional weighing hook to the bottom of the balance, attach the hanging pan, and then immerse the hanging pan in a tank containing the sample liquid.

3) Press the key until "d" is displayed.

4) Press the key.

5) Load the reference weight on the pan of the balance.

6) After the stability symbol is illuminated, press the key.

may be displayed but does not indicate a malfunction.

7) Load the reference weight on the hanging pan and immerse it in the sample liquid. The specific gravity of the sample liquid is displayed.

8) Repeat steps 4 through 7 for each additional sample.

Note:

- Up to four decimal places are displayed for specific gravity. Since it may not be possible to stabilize the balance using all 4 places, 1d/10d switching is possible.
- When loading the sample on the pan, immerse the entire sample in the liquid.
- To release the , or units, set the value to zero.
- When the optional Specific Gravity kit is used, refer to the Instructional Manual of the Specific Gravity kit for the procedure.

2.11 System Setting Menu ■ Std : ERUS

The SYSTEM SETTING menu is used to set the items that pertain to or are controlled by the balance.

2.11.1 Date for the Built-in Clock

- 1) Select Menu Map item [63].
- 2) Press the key key.
- 3) Set the last two figures of the year, month and day, using the key and key keys. Then press the key key.

Example:

February 1st, 1997 Set as 97. 02. 01

February 29th, 2004 Set as 04. 02. 29

Note:

- The built-in clock corrects for the leap year automatically.
- The moment the key key is pressed in step 2 above, seconds are set to zero. If the date is set after setting the time, the second value will be incorrect. It is important to set the date first and then the time, or to correct the seconds value using the \pm second correcting function described later.

2.11.2 Time for the Built-in Clock S-dtSCr

- 1) Select Menu Map item [64].
- 2) Press the key key.
- 3) Use the key key and key keys to set the time in the 24 hour system, then press the key key.

Example: 1 o'clock 23 minutes in the afternoon Set as 13 : 23

Note: The moment the key key is pressed is 00 seconds.

2.11.3 Display During Standby S-dtSCr

Determine what is to be displayed during a power supply standby.

- | | | |
|--------------------|-------|-----------------------------------|
| Menu Map item [65] | SS-t | Displays the time during standby. |
| Menu Map item [66] | SS-d | Displays the date during standby. |
| Menu Map item [67] | SS-no | Displays nothing during standby. |



Convenient Functions of Time Display

The following functions are available when the time is displayed during standby.

Seconds display function:

Press the  key to enable the display/non-display of the seconds value.

2.11.4 Measurement Control System

Items related to the calibration of the balance and those set by the administrator are summarized in this menu.

2.11.4.1 Calibration Report

Turns the calibration report function on/off. Use this to generate a calibration report as for GLP, GMP, or ISO9000. An electronic printer (special accessory) is required to print the report.

Menu Map item [68]  Calibration report is created.

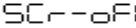
Menu Map item [69]  Calibration report is not created.

2.11.4.2 Balance ID

Individual balances can be identified by the serial number on the main body of the balance. The user can add a four-digit ID number to the calibration report.

Set with Menu Map item [70]. Use a 4-digit number from 0000 to 9999.

2.11.4.3 PCAL Password

Enter a 4-digit number from 0000 to 9999 with Menu Map item [71].

It is recommended that the balance administrator set this password to prevent an unauthorized person from incorrectly calibrating the built-in calibration mass.







 Section 2.6.4 "PCAL - Calibration of the Built-in Weight"

Note: When the menu is reset, the PCAL password is reset to 9999.

2.12 Communication Menu (blinking)

2.12.1 Overview

This menu is used to set the specifications for communication between the balance and a personal computer or electronic printer.

Note: This menu affects both the RS-232C and DATA I/O at the same time. For the instrument to be connected to the DATA I/O connector of an electronic printer set the specifications for communication of the balance to the default settings, which are  [76],  [77],  [83],  [89],  [92], and  [94].

2.12.2 Handshaking - HFbPSd

Handshaking determines whether the peripheral equipment can receive communication data from the balance. This function does not relay the status of the balance to the peripheral equipment.

The balance is able to receive as long as there is space in the receiving buffer of the balance. This function operates once OFF is displayed, operation in other states is not guaranteed.

When the balance output is retained by handshaking, the display of the balance is locked. Determine the specifications for handshaking.

Menu Map item [73] H-OFF Software handshaking is not performed.

Menu Map item [74] H-SOFF Software handshaking is performed.

After the balance receives X-OFF (13H), the balance output is retained.

After the balance receives X-ON (11H), the balance output is initiated.

Menu Map item [75] H-HARD Hardware handshaking is performed.

When DTR is OFF, the output from the balance is retained.

When DTR is ON, the output from the balance is initiated.

Menu Map item [76] H-TM Timed hardware handshaking is performed.

2.12.3 Format - HFbPSd

Set the balance output format.

Menu Map item [77] F-EB The standard format for the Shimadzu electronic balance.

Menu Map item [78] F-PR-EEB The old output format for the Shimadzu electronic balance

The old output format is employed in the following models.

EB-500, 5000, 280, 2800, AEL-1600, EB-50K (except -15)

Note: In this format, the number of the lowest place of Menu Map item [70] SC- is assigned to identify the balance.

Menu Map item [79] F-PR Compatible format for the PR and SR series of Shimadzu electronic balances. Available commands, functions and responses are limited.

Menu Map item [80] F-IPS Compatible format for the IPS series of Shimadzu electronic balances. Available commands, functions and responses are limited.

2.12.4 Communication Speed -HFbPSd

Select the communication speed (300, 600, 1200, 2400, 4800, 9600, 19200, or 38400 bps). Number of b-xxx shows bps (bits/second). Baud rate and bps are the same value.
Set with Menu Map items [81] to [88].

2.12.5 Parity / Bit Length -HFbPSd

Select the parity and bit length.

Menu Map item [89]	P-no	No parity, 8-bit length
Menu Map item [90]	P-odd	Odd number parity, 7-bit length
Menu Map item [91]	P-even	Even number parity, 7-bit length

2.12.6 Stop Bit -HFbPSd

Select the number of stop bits.

Menu Map item [92]	S-1	Stop bit 1.
Menu Map item [93]	S-2	Stop bit 2.

2.12.7 Delimiter -HFbPSd

The "delimiter" is used to separate individual pieces of data or commands. Set the delimiter as follows:

Menu Map item [94]	d-CR	Set to CR(0DH).
Menu Map item [95]	d-LF	Set to LF(0AH).
Menu Map item [96]	d-CR-LF	Set to CR+LF(0D0AH).
Menu Map item [97]	d-win	Transfers the data directly to Microsoft® Windows®. This is equivalent to pressing the Enter key of the personal computer.
Menu Map item [98]	d-win-	Transfers the data directly to Microsoft® Windows®. This is equivalent to pressing the right cursor key of the personal computer.

Note: d-win | • d-win-

 Section 3.2.4 "Windows® Direct".

When these Menu Map items are set, it is not possible to send commands to the balance from the peripheral instruments. The personal computer and electronic printer cannot be used at the same time.

3. Connecting Peripheral Instruments

A variety of peripheral instruments are available for use with the BW and BX series balance, such as an electronic printer, keyboard or personal computer.

This chapter describes how to connect and use peripheral instruments.

3.1 EP-60A Electronic Printer

- 1) Use the default communication settings for the balance listed below.
Menu [76] [77] [83] [89] [92] [94]
H-tm F-Eb b- i200 P-no S- i d-Cr
- 2) Disconnect the power to the balance and EP-60A Electronic Printer.
- 3) Connect the DATA I/O connector of the balance to the EP-60A using the attached cable of the EP-60A.
- 4) First turn ON the power to the balance, then to the EP-60A.

3.2 Personal Computer - RS-232C -

3.2.1 Connecting the Cable

 **Caution**

Signals other than RS-232C are also output by the BW and BX series balances through the RS-232C/AUX connector. If these signal lines are incorrectly connected, damaged may occur to the personal computer or balance. Correctly connect an appropriate cable for communication between the balance and personal computer.

All types of personal computers may not operate normally when connected with the optional RS-232C cable according to the diagram.

(1) IBM PC/AT and its compatible personal computers (D-sub 9-pin)

Personal computer side

Balance side

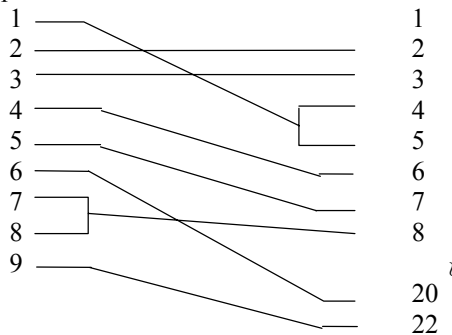

FRAME

SHIELD

FRAME

(This wiring cable is not always necessary.)

(2) IEEE Standard (D-sub 25-pin)

Personal computer side

Balance side

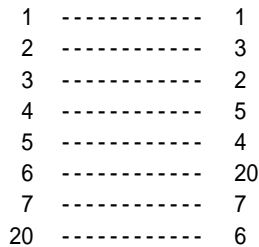

3.2.2 Data Format

The following explanation is applied when $F-Eb$ is selected.

For other formats, refer to the data corresponding to the compatible machine.

Note: \uparrow indicates space code and <delimiter> indicates delimiter code.

(1) For the measured value`

First character: Minus: '-' Non-minus: space

2nd to 11th characters: Numeric values or "[", "]" are flushed right. The position of the decimal point varies depending on the type of instrument.

12th to 13th characters: Unit such as g \uparrow or kg

14th to 15th characters: Delimiter

Note: When the delimiter is $d-Cr$ or $d-LF$, the 13th character is not present. When printing stability information, the following characters are put in front of the first character mentioned above.

Stable time: S

Unstable time: D

When the delimiter is $d-w r \uparrow$ or $d-w r-$, the special format is used

instead of that described above.

- (2) For of $\square L$ or $- \square L$
- | | | |
|---------------|--|-------------|
| $\square L$ | $\square \square \square OL \square \square \square$ | <Delimiter> |
| $- \square L$ | $- \square \square \square OL \square \square \square$ | <Delimiter> |

3.2.3 Using Command Codes

Note: If communication conditions are incorrectly set, a communication error $\square \square \square \square \square \square \square \square$ is displayed.

- (1) Commands that end with a number, character, or symbol other than [=]:
Transmit to the balance with a delimiter for each command code.

Example 1: PRINT<CR> ... The same operation as pressing the
key

- (2) Commands that end with a [=]: Transmit the number to the balance with a delimiter.

Example 2: TIME=1234 <CR> .. 12:34 is set as the current time.

Example 3: P.TARE=1.23 <CR> (example of type of the second decimal place).
...1.23g is set as a Pretare value.

Example 4: P.TARE=0.00 <CR> (example of the second decimal place)
...Clears (cancels) the Pretare value.

Note: Number of digits, decimal point, position of decimal point of the numeral transmitted succeeding to '=' are the same as the case of setting the numeric value using the AKB-301 Application Keyboard.

Number of digits below the decimal point is as follows.

S-type and **H-type:** Use the same number of decimal places as in the gram-display.

This restriction does not apply to USER=, SOLID=, and LIQUID=.

Example 5: MENU=4630 <CR> (4-digit number after [=])
This is the same in the following operation.

... from mass display, press the key four times, the
press the key once and the press the key
six times. This returns to the same display as if the key
was never pressed.

Press the key once, the key three times, and
the key once more.

This example indicates that $\square \square \square \square \square \square$ is selected.

Note: If there is 0 in the four-digit number, the setting is complete at that point and menu selection is ended.

The result of this command varies depending on the type of the balance.

Example 6: #=2.56 <CR>

Example 7: #=12.345.67 <CR>

A personal computer can instruct the weighing and display a specific number on the balance.

With the commands in Example 6 & 7, [#2.56] and [#12.345.67] are displayed on the balance. When the

operator presses the key, the character string '2-56<CR>' and '12-345-67<CR>' are output from the balance.

(3) Echo back command

The balance again transmits the character strings of N pieces included between an echo back command '{' or '}' and the delimiter.

An unprocessed echo back command is not left in the receiving buffer of the balance, $N \leq 30$.

Example 8: ABCDEFGH12345<CR>

... After receiving this command, the balance outputs ABCDEFGH12345<CR>. The printer can print this character string.

Note: Only capital alphabets and a part of symbols (decimal point, symbol etc.) can be used when printing with an electronic printer. A maximum of 15 characters per line.

(4) Command codes for F-EB and F-PEEB

(i) Commands related to output

- D01 Continuous output
- D03 Continuous output with stability information
- D05 Single output
- D06 Auto Print setting (type of Auto Print is set separately)
- D07 Single output with stability information
- D09 Release of continuous output and Auto Print

(ii) Commands related to operation keys

POWER Equivalent to the key

Q Equivalent to the key

MENU Equivalent to the key

TARE	Equivalent to the	key
T	Equivalent to the	key
RANGE	Equivalent to the	RANGE key
B	Equivalent to the	RANGE key
UNIT	Equivalent to the	key
PRINT	Equivalent to the	key
POWER+	Equivalent to holding the	key for approximately 3 seconds.
MENU+	Equivalent to holding the	MENU key for approximately 3 seconds.
UNIT+	Equivalent to holding the	key for approximately 3 seconds.
PRINT+	Equivalent to holding the	key for approximately 3 seconds.
RECALC	Equivalent to the	RECALC key of the AKB-301 Application Keyboard
C	Equivalent to the	[C] key of the AKB-301 Application Keyboard

(iii) Commands related to Application Measurement

PEAK	Sets the Peak Hold mode.
AZERO	Sets the Auto Zero mode ON.
INTERVAL	Sets the Interval Timer mode.
MEMORY	Sets the Memory mode.
M	Immediately operates after setting the Memory mode,.
ADDON	Sets the Auto-Memory and Zeroing mode.
+	Immediately operates after setting the Auto-Memory and Zeroing mode,.
A	Sets the Animal Weighing mode.
ANIMAL	Sets the Animal Weighing mode.
R	Releases the Application weighing mode.

(iv) Commands related to unit conversion

g	Switches to "g" unit
kg	Registration of "kg" unit and switching
mg	Registration of "mg" unit and switching
PERCENT	Registration of "%" unit and switching
%	Sets 100% when display is in "%" unit.
G	kg <- -> % switching
PCS	Registration of "PCS" unit and switching
CT	Registration of "karat" unit and switching
MOM	Registration of "monme" unit and switching
SDENSE	Registration of "solid density" unit and switching
LDENSE	Registration of "liquid density" unit and switching
CU	Switches to "user" unit (Set the conversion coefficient beforehand.)
RSTUNIT	Returns the default units.

(v) Readout commands of set value

TARGET	Readout of target set value
LIMIT	Readout of limit set value
G.LO	Readout of lower limit set value in Group mode
G.HI	Readout of upper limit set value in Group mode
L.LO	Readout of lower limit set value in Level mode
L.HI	Readout of upper limit set value in Level mode
UW	Readout of unit weight set value
G/PCS	Equivalent to g/PCS key
CALWT	Readout of external weights set value for span calibration
ACALT1	Readout of ACAL time 1
ACALT2	Readout of ACAL time 2
ACALT3	Readout of ACAL time 3
P.TARE	Readout of Pretare set value
ZRNG	Readout of Zero Range set value
USER	Readout of user unit conversion coefficient
VOL	Readout of reference weight set value
DENSE	Readout of surrounding liquid density set value
I.TIME	Readout of Interval Timer set value

Note: The command to read out the numerical value settings can only be given by the personal computer.

(vi) Commands for numeric value setting

CALWT=	Sets external weights value for span calibration.
ACALT1=	Sets ACAL time 1.
ACALT2=	Sets ACAL time 2.
ACALT3=	Sets ACAL time 3.

P.TARE=	Sets Pretare value.
ZRNG=	Sets Zero Range value.
UW=	Sets unit weight.
USER=	Sets user unit conversion coefficient.
VOL=	Sets volume of reference weight.
SDENSE=	Sets surrounding liquid density.
I.TIME=	Sets interval timer value.
DATE=	Sets the date.
TIME=	Sets the time.
TARGET=	Sets the target value.
LIMIT=	Sets the limit value.
G.LO=	Sets the lower limit value of Group Display mode.
G.UP=	Sets the upper limit value of Group Display mode.
L.LO=	Sets the lower limit value of Level Display mode.
L.UP=	Sets the upper limit value of Level Display mode.
PCS=	Sets the arbitrary loading piece.
#=	Corresponds to numeral keys of AKB-301 Application Keyboard.
ID=	Sets ID.
PASSSET=	Sets PCAL password.
PASS=	Inputs PCAL password.

(vii) Commands of special functions

CAL	Enters Span Calibration mode.
C18	Enters Span Calibration mode.
LOCK	Sets menu lock.
RELEASE	Releases menu lock.
TIME	Readout of date and time
ADJCLK	Adjusts ± 30 seconds.
RSTMN	Menu reset
MENU=	Sets arbitrary menu.
{	Echo back
}	Echo back
[□]	Sets to Multi-Connection mode. (□ represents a lower-case alphabet character.)

Note: For Multi-Connection mode, refer to Section 3.3.5 "Multi-Connection Mode".

(5) Compatible commands with Mettler® Electronic Balances

S	One time output at a stable state
SI	Immediate one time output
SIR	Continuous output
SR	Continuous output at a stable state
T	Taring after stabilized
TI	Immediate taring

Z Zero setting (same as immediate taring)

(6) Compatible command with Sartorius® Electronic Balances

<ESC>P One time output

<ESC>T Taring

Note: <ESC> indicates escape code (1BH).

3.2.4 Windows® Direct Function

Note: For Windows®95 Version 4.00.950B, see page 69 “Compatibility Notification Regarding Linking of “Windows® Direct” Function with Windows®95 Version 4.00.950B.”

The BX-K and BW-K series balance can transfer data directly to a personal computer running Lotus 1-2-3, Excel, or other applications of Windows®*.

3.2.4.1 Preparation (Installation)

Install according to the procedure described below.

- 1) Supply power to the balance and set the condition for communication as follows.

Menu	[74]	[77]	[81]	[89]	[92]
	H-SOFT	F-EB	b-300	P-no	S-!
Menu	[97]	[98]			
	d-w in !	d-w in-			

- 2) Keep pressing the key and complete selection of the balance menu.
- 3) Disconnect the power to the personal computer and balance.
- 4) Connect the personal computer to the balance with the RS-232C cable.
- 5) Turn ON the power to the personal computer only and start Windows®*.
- 6) Click "Start", choose "Settings" and "Control Panel" then select "Accessibility Options."
- 7) Confirm that there are no check marks for any items on tabs including "General."
- 8) Put a check mark at "Support Serialkey device" in the "General" tag. This is the only check mark on all the tabs.
- 9) Open "Settings."
Select the serial port corresponding to the RS-232C port of your personal computer. (Serial port: any one of COM1 to 4. Mostly, COM1)
- 11) Select a "Baud rate" of 300.
- 12) Click "OK."
- 13) Click "Apply."
- 14) Click "Start", point to "Shut Down" then click "Restart the computer?".
- 15) After Windows®* has completely started, turn on the power supply to the balance.

It is not necessary to perform the Windows®* control panel setting operation every time.

3.2.4.2 Checking Operations

- (1) Open the "Note pad" attached to Windows®* (or the application in use).
- (2) Press the key on the balance.
- (3) Verify that the numeric value displayed on the balance is displayed on the screen of personal computer.
- (4) End the operation using the standard ending procedure.

Windows®* = Windows 95, Windows 98, Windows Me, Windows 2000

3.2.4.3 Activate Windows

To ensure correct operation, activate Windows®* using the following procedure.

Procedure

- (1) Disconnect the balance power supply.
- (2) Activate Windows®* and wait until activation is complete.
- (3) Plug the AC adapter into the outlet and turn ON the balance.

Note: Turning ON the balance before Windows®* is completely activated may cause incorrect operation.

Note: This function may not operate on a PC on which a normal U.S. version of Microsoft Windows®* does not operate. Some types of personal computers may not be able to use this function or some features may be limited. Shimadzu does not guarantee that this function can be used on all the PCs without any problems currently or in the future.

- Shimadzu is not liable for any direct or indirect problems caused by this function. It is recommended that important data or programs on your PC be backed-up before using this function. For the operation of Windows®* or the PC, refer to commercial tutorials or the appropriate instruction manual.
- It is necessary to have the "Accessibility Options" function of Windows®* installed on the PC. To install "Accessibility Options", select "Start" -> "Setting" -> "Control panel" -> "Add /Remove Programs" and open the "Windows Setup" tag. Place a check mark on "Accessibility Options." For more information, see the Windows®* instruction manual.
- Once the serial key device is made effective, software which uses the RS-232C port on that PC does not operate correctly, unless it is made ineffective again. If an external modem, plotter or etc. is connected, remove the check mark placed on "Using the serial key device" and re-activate the OS after connection to the balance is terminated.

3.2.4.4 Troubleshooting

When the Function Does Not Operate At All:

- For some notebook PCs, it is possible to exclude the RS-232C port for energy saving purposes. Set the PC so that the RS-232C port can be used.

- Change the settings of COM 1 to 4. Re-start Windows®* after the changes are complete.
- Verify that the correct RS-232C cable is being used.

Windows®* = Windows 95, Windows 98, Windows Me, Windows 2000

When the Function Intermittently Malfunctions:

- Use a communication speed of 300bps. Depending on the processing ability of the PC, this function may operate incorrectly if communication speed is too high.
- Send the next data only after the current one is displayed on the screen. Depending on the processing ability of the PC, this function may operate incorrectly if interval of data transmission is too short.
- Do not touch the keyboard or the mouse while the balance is transmitting data. Stop the data transmission and confirm that no data is entering the PC before touching the keyboard or the mouse.
- This operation may be incorrect when the displayed value is not a weight value (i.e. error code or time).
- The unit designation is not transmitted.
- This function may operate incorrectly depending on the settings of various lock keys of the keyboard such as the NUMLOCK or cursor key lock. Change the state of the lock and function keys on the PC keyboard.
- The peripheral devices connected to the DATA I/O such as Electric Printer EP-50 cannot be used with this function.
- When this function is used, a command cannot be sent from the peripheral device to the balance.
- Set the data formats, such as decimal places and units, in each application.

3.2.5 Multi-Connection Mode

A maximum of 26 BX-K/BW-K series balances can be connected to one personal computer at the same time.

This is called "Multi-Connection mode." To use the balance in this mode, prepare RS-232C cables in the number of balances connected, and the optional IFB-102A RS-232C Interface.

Connecting Method

Example for connecting 10 units of BW/BX series balances to one personal computer is shown in the diagram below.

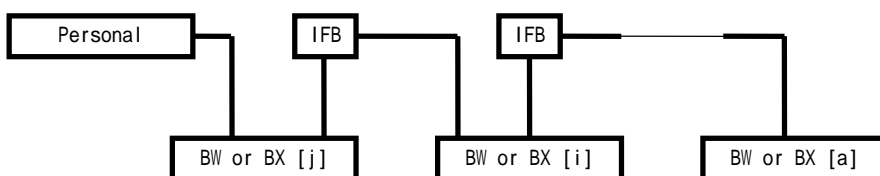

Assignment of Identification Name

In this example (10 balances connected to one computer), assign the identification name in lower-case alphabets.

Since 10th character of alphabet is "j," assign "j" to the balance closest to the personal computer, "i" to next closest balance, and so on, back to "a."

Setting to Multi-Connection Mode

- 1) Adjust the communication menu settings of all the balances to the specification of the personal computer, and then, turn off the power to all balances.
- 2) Start supplying the power to the whole system. Wait until all balances display OFF.
- 3) Send "[α] <delimiter>" from the personal computer.
α is the name of the balance next to the personal computer. In the example above, lower-case "j."
This command is valid only one time after turning the power ON.
Respective balances automatically enter the Multi-Connection mode and the mass is displayed.
On this process, the name smaller than the sent command by one, i.e. "[i] <delimiter>", is returned.
- 4) This procedure completes the setting to the Multi-Connection mode.

Command Codes in the Multi-Connection Mode

Only the commands shown below are valid in the Multi-Connection mode.

(α is the name of the balances.)

[α]TARE	Same as the operation of pressing the	key of the balance "α."
[α]T	Same as the operation of pressing the	key of the balance "α."
[α]POWER	Same as the operation of pressing the	key of the balance "α."
[α]Q	Same as the operation of pressing the	key of the balance "α."
[α] PRINT	Same as the operation of pressing the	key of the balance "α."
[α]D05	Same as the operation of pressing the	key of the balance "α."
[α]D07	Same as sending the D07 command to the balance	"α."

[α]UNIT	Same as the operation of pressing the	key of the balance
	"α."	
[α]RANGE	Same as the operation of pressing the RANGE key of the balance	
	"α."(Valid only for D-type)	
[α]CAL	Same operation as sending the CAL command to the balance	"α."
[α]UNIT+	Same as the state of holding down the	key of the balance
	"α."	

Format of Output Data from the Balance

The output data from the balance "α" is performed with the following format.

"[α]" data <delimiter>

Format of the load data is the same as the normal output form (F-Εb).

Operation is not guaranteed for the data containing characters, such as printing of date, time, and calibration document etc.

Restricted Items in the Multi-Connection Mode

Multi-Connection mode is not designed for each balance to independently send the data.

This mode is for sampling the data by control of multiple balances with one PC.

This is not the function to support multiple balances for sending the data separately.

When multiple number of data and commands exist on the system at the same time, the balance may not operate normally. For example, multiple data may exist simultaneously on the system when using multiple balances in the Application Measurement mode such as Auto Print or Continuous Output, or pressing the PRINT key. Normal operation cannot be guaranteed.

Peripheral instruments connected to the DATA I/O or IFB-102A connector, such as an EP-50 Electronic Printer, cannot be used.

The communication formats can only be used with F-Εb. Delimiters cannot be used with α-w ια ! or α-w ια-.

It will take an average $0.05 \times N$ seconds for the data from the personal computer to reach balance unit N, even at setting of 38400 bps. Also, it will take almost the same time for the data from the balance in the Nth position to reach the personal computer.

Cancellation of Multi-Connection mode

Multi-Connection mode cannot be canceled unless the power for all balances is turned OFF.

3.3 Optional AKB-301 Application Keyboard

The optional AKB-301 Application Keyboard is provides numeric keys which are very convenient for inputting numbers. It is possible to perform various numeric settings such

as, piece count and threshold value of graphic display (comparator), as if you were operating a pocket calculator.

Use of the AKB-301 Application Keyboard is recommended for performing piece count and pass or failure judgment in daily operation

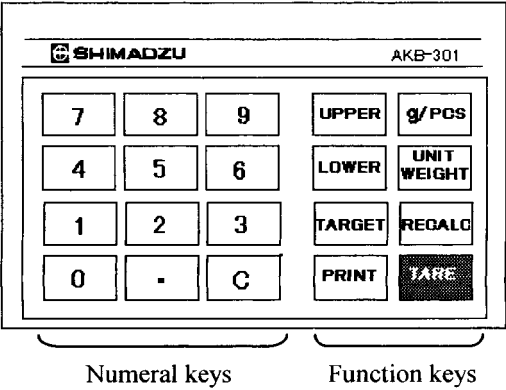

3.3.1 Basic Information

3.3.1.1 Connection

- 1) Disconnect the power to the balance.
- 2) Connect the AKB-301 cable to the KEY connector on the back of the balance.
- 3) Turn on the power to the balance.

3.3.1.2 Overview of Use

- 1) To set numeric values ➡ Press a function keys after the number keys.
- 2) To check the set numeric values ➡ Press only a function key, not a number key.
- 3) To return to the mass display ➡ Press the C key.
If numeric keys other than C are pressed, the # symbol illuminates to indicate that a number is being entered.

3.3.1.3 Summary of Function Keys

Function key	Function	
	When this key is pressed after the numeric keys	If this key is pressed while the numeric keys are not pressed *1
UPPER key *2	Sets UPPER value of graphic display.	Displays UPPER value of graphic display.
LOWER key *3	Sets LOWER value of graphic display or sets UNIT value.	Displays LOWER value of graphic display or displays UNIT value.
TARGET key *4	For target display, sets TARGET value.	For target display, displays TARGET value.
g/PCS key	Recalculates the weight with regard to the present load as the input value (pieces) and saves.	Switches gram-display unit and displays in piece unit.
UNIT WEIGHT key	Stores the numeric values entered as the unit weight.	Displays the unit weight presently stored.
RECALC key	Nothing is done.	When piece is displayed, divides the present load by the present displayed piece count to recalculate the unit weight.
PRINT key *5	Outputs the input numerals.	Outputs the displayed value.
TARE key *5	Sets Pretare value.	Performs taring.

*1 When these values are displayed, the * and # symbols are illuminated on the screen.

Pressing the C key returns these displays to the mass display.

These displays can be output (printed) with the PRINT key.

*2 This key functions only when a comparator is used in Group or Level mode. UNIT is displayed for other modes.

- *3 When a comparator is used in Group or Level mode, LOWER is the target value. LIMIT is the target value in the Target mode. ERR is displayed for other modes.
- *4 This operation is performed only in Target mode. ERR is displayed for other modes.
- *5 Operation of the TARE and PRINT keys are the same as keys on the main balance body.

3.3.2 Example of Use

3.3.2.1 Using with a Comparator

Note: The decimal key of the AKB is not used for setting comparator values. The decimal place is set automatically according to the display capabilities of the balance.

Preparation

Set the kind of graphic display you desire to use with menu selection.

- 1) From the mass display, press the MODE key three times and the MENU key once.
- 2) Use the UP and DOWN keys to set the desired graphic display mode.

(1) Target display mode

Setting the target value

Example: Press the numeric keys for 10000 and then the [TARGET]key.

➡ The Target value is set to 10000.

Setting the limit value

Example: Press the numeric keys for 5000 and then the [LOWER] key.

➡ The Limit value is set to 5000.

Checking the target value

Press the [TARGET] key to display the set value.

Checking the limit value

Press the [LOWER] key to display the set value.

After checking, press the g/PCS key to return to the mass display.

Note: ERR is displayed if the [TARGET] key is pressed without being in the Target display mode.

(2) In Comparator mode (group display and level display)

Setting the upper limit value

Example: Press the numeric keys for 20000 and then the [UPPER] key.

➡ The upper limit value is set to 20000.

Setting the lower limit value

Example: Press the numeric keys for 10000 and then the [LOWER] key.

➤ The lower limit value is set to 10000.

Checking the upper limit value

Press the [UPPER] key to display the set value.

Checking the lower limit value

Press the [LOWER] key to display the set value.

After checking, press the g/PCS key to return to the mass display.

3.3.2.2 Piece Counting

Use the [g/PCS], [UNITWT], and [RECALC] keys.

Counting Pieces

Use the following procedure to count pieces based on a sample with an arbitrary number of pieces. For example, to recalculate the unit weight based on 25 pieces and perform piece counting.

Example Procedure

- 1) Load the container and press [TARE] key or zero the balance.
- 2) Count 25 pieces and load them on the pan.

Note: If in gram-display, the gram value of the 25 piece sample is displayed. If in PCS display, the value is converted into piece display using the previously stored unit weight. The display may not be 25 pieces.

- 3) Press the numeric keys for 25 and then the [g/PCS] key.
- 4) Piece count is now displayed in the new unit weight.

Recalculating the Unit Weight

To recalculate the unit weight with the currently displayed piece count, press the [RECALC] key when the correct piece count is displayed.

Inputting Unit Weight

To input a unit weight directly, (for example, 1.234). Press 1.234 and then press the [UNIT WEIGHT] key. Set the unit weight in "g". A value using the maximum number of digits displayed by the balance can be set. Use the decimal point key on the AKB when entering this value.

Recalling the Unit Weight

Press the [UNIT WEIGHT] key.

Switching from g to PCS

Press the [g/PCS] key to switch between the "g" unit and "piece count" unit.

3.3.2.3 Other Uses

Setting the Pretare Value

Example: Enter 1.234 and press the [TARE] key.

➤ 1.234 g is set as the Pretare value.

Note: Number of decimal places is set as follows:

H-type and **S-type** ... with number of decimal places at 1d gram-display unit

If not correct, $\bar{E}r$ is displayed.

Example: To cancel the Pretare value for a balance with three decimal places:

X wrong example: 0 [TARE]

O correct example: 0.00 [TARE]

Checking the Pretare value

Press and hold the [TARE] key for approximately 3 seconds. Press the [TARE] key again to return to the mass display.

Cancel a Pretare Value

Cancel a pretare value by setting the value to zero using the correct decimal placement for the balance.

Output Keyboard Numbers to Peripheral Devices

Arbitrary numbers with a maximum of seven digits can be output using the numeric keys and the [PRINT] key.

The sample number can be input at the balance and transferred with the balance output to the personal computer.

Example: To input 123-456:

Enter 123.456 and press the [PRINT] key.

Setting a Numeric Menu Value

Use the number keys of the AKB to enter numeric values during menu selection.

Numbers are set sequentially starting from the blinking digit. The decimal point can be set using the decimal point on the AKB.



Last Menu Recall function with AKB-301

Last Menu Recall function is helpful when changing the numeric values for the same

Menu Map item. To use this function, press and hold the key until the menu is displayed.

3.4 Foot Switches

A foot switch is convenient when the operator must work with both hands. Two types of foot switches are available.

FSB-102T has the same operation as the key of the balance

FSB-102P has the same operation as the key of the balance

Note: Either one of the foot switches can be connected at a time. The foot switches cannot be used together with the AKB-301 Application Keyboard.

3.5 Hook for Below-Balance Weighing

This hook is useful for conducting measurements with the sample suspended beneath the balance, such as in specific gravity measurement.

Attachment method

Attach the below-balance weighing fitting by screwing the supplied screws into the screw holes for the transportation screws on the bottom of the balance (2 places), as shown in the diagram on the right, until the screws cannot be tightened anymore.

Note:

Be careful to ensure that no undue force is applied to the fitting when putting down the balance while the fitting is attached. Otherwise, the balance may not operate correctly. In particular, do not put down the balance in a location where there is no hole for below-balance weighing.

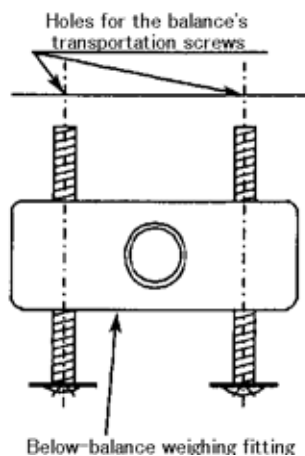

4. APPENDIX

4.1 Part List

4.1.1 Standard Accessories and Maintenance Parts

Name	Part No.	Remarks
Pan ASSY , KW	321-41074	For the BW-K
Pan ASSY	321-40919-01	For the BX-K
Pan support cap	321-40965-04	
Vinyl cover	321-40924	
Double-sided tape for fixing the vinyl cover	320-02138	
Calibration weight stopper screw	321-41046	For the BW-K
Calibration mass cover setscrew (SUS bind M4x8)	020-37512	For the BW-K
Transportation screw (SUS Sems P3BK M4x16)	020-46551	
Caster ASSY	321-30070-03	
AC adapter	321-61610	For AC100V

4.1.2 Options

Name	Part No.	Remarks
EP-50 Electronic Printer	321-34986	Dot matrix type
EP-60A Electronic Printer	321-42008-10	Thermal type
RS-232C cable 25P-9S (1.5m)	321-60117-01	For PC/AT, DOS/V
RS-232C cable 25P-25P(1.5m)	321-60116-01	For some NEC PC-98 models (Standard IEEE size)
RS-232C cable 25P-14P (2m)	321-60118-01	For NEC PC-98 notebooks (Centro-half)
IFB-102A RS-232C Interface	321-41167-10	Required for multiple connections
Pocket computer printer CD-PCE650	320-02144-14	
Application measurement key AKB-301	321-53382-01	
FSB-102PK Foot Switch	321-60110-11	Equivalent to PRINT key on main body
FSB-102TK Foot Switch	321-60110-12	Equivalent to TARE key on main body
Battery PC7200B	321-61691-01	Rechargeable type. For AC100V only
Hook for below-balance weighing	321-40962	

Note:

- Part No. and specification are subject to change without notice.

- It is not guaranteed that RS-232C cable will conform to all computers.

4.2 Table of Unit Conversion Constants

SCROLL ORDER	MENU	UNIT	Conversion coefficient (g=)	Note (display)
[54]	U-kg	kg	0.1	
[55]	U-mg	mg	1000	
[56]	U-%	%		
[57]	U-pcs	Pcs		
[58]	U-ct	ct	5	
[59]	U-mom	Mom	0.266667	
[60]	U-□d	DS		
[61]	U-d	DL		
[61a]	U-Lb	Lb	0.00220462	
[61b]	U-Oz	Oz	0.0352740	
[61c]	U-Ozt	Ozt	0.0321507	
[61d]	U-HK	TL-HK	0.0267165	A triangle symbol displays
[61e]	U-HK	TL-HK(Jw l)	0.0267173	Three triangle symbols display
[61f]	U-SporE	TL-S'pore	0.0264554	
[61g]	U-tiwAn	TL-Taiwan	0.0266667	A triangle symbol displays
[61h]	U-tiwAn	TL-Taiwan	0.0266667	Three triangle symbols display
[61i]	U-mal	TL-Malaysia	0.0264600	
[61j]	U-ChinA	TL-China	0.0266071	A triangle symbol displays
[61k]	U-ChinA	TL-China	0.0266071	Three triangle symbols display
[61l]	U-dwt	dwt	0.643015	
[61m]	U-GN	GN	15.4324	
[61n]	U-t	t	0.0857339	
62	U-USER			Set by user

4.3 Specifications for the RS-232C/AUX Connector

Pin number	Name	Function	Remarks
1	FG	Frame ground	
2	TXD	Data output	
3	RXD	Data input	
4	RTS	Internal connection with CTS	
5	CTS	Internal connection with	

		RTS	
6	DSR	Handshake (receiving)	
7	SG	Signal grounding	
8	NC	Blank	
9	NC	Blank	
10	NC	Blank	
11	NC	Blank	
12	NC	Blank	
13	NC	Blank	
14	NC	Blank	
15	NC	Blank	
16	NC	Blank	
17	NC	Blank	
18	NC	Blank	
19	NC	Blank	
20	DTR	Handshake (receiving))	
21	NC	Blank	
22	NC	Blank	
23	NC	Blank	
24	NC	Blank	
25	NC	Blank	

Note: NC= No connection within the balance.



4.4 Error Display List

4.4.1 General Display

Display	Description of message
---	Wait for next display.
- 10d-	Minimum display resolution is decreased by one decimal place.
- 1d-	Minimum display digit is returned to original state.
-t mE-	Date and time are being output.
Abort	Operation was aborted.
APL End	Application Measurement was released.
d over	Calibration check detects too large error.
d Under	Calibration check detects too large error.
LoCKEd	Menu lock is applied.
rELEASE	Menu lock is released.
rESEt	Menu was reset.
SEt	Contents of new setting and coefficient were stored.
oFF	Reset by power failure.
wA it	Built-in weight is moving. Wait.
All numerals blinking	Place the displayed calibration mass.

4.4.2 Error Display

Error display	Description	Countermeasure
CAL E1	The load on the pan is unstable at calibration. Only one of the calibration levers is working.	Avoid wind and vibration.
CAL E2	The drift of zero point is large at calibration.	Empty the pan.
CAL E3	The drift is large at the time of PCAL.	Use correct weight.
CAL E4	The drift is large at span calibration.	Use correct weight.
CAL E5	Weight is wrong.	Use correct weight.
CHE X	Stops when this is displayed.	*
ComErr	Received command code is not correct.	Check delimiter etc.
dSP oL	Integer of the displayed unit exceeded 7 digits.	Decrease the load.
Err OX	Failure in the balance.	*

Err 10 PCAL password error. “—” is displayed after the error.	Check the password. Press the  key and return the balance to mass display mode.
Err 20 Attempted to set improper numeric value.	Review the numeric value and decimal places.
Err 21 Necessary conditions and numeric values are not set.	Check graphic display mode.
Err 22  key was pressed during menu lock.	Release menu lock.
Err 23 Mode for operation is different.	Check graphic display mode.
Err 24 Cannot be stored, as the supply voltage is abnormal.	Check the supply voltage.

*Contact your Shimadzu representative.