

Atomic Absorption Spectrophotometers

AA-7000 Series



AA-7000 Series

Atomic Absorption Spectrophotometers

Reaching Even Greater Heights

Enhanced Flame Analysis

World-Class High-Sensitivity Furnace

Improved Dual Atomizer System

Advanced Safety Technology



System Configuration can Evolve with Your Needs

The AA-7000 Series can be upgraded by adding units to allow the system to handle the analysis targets.

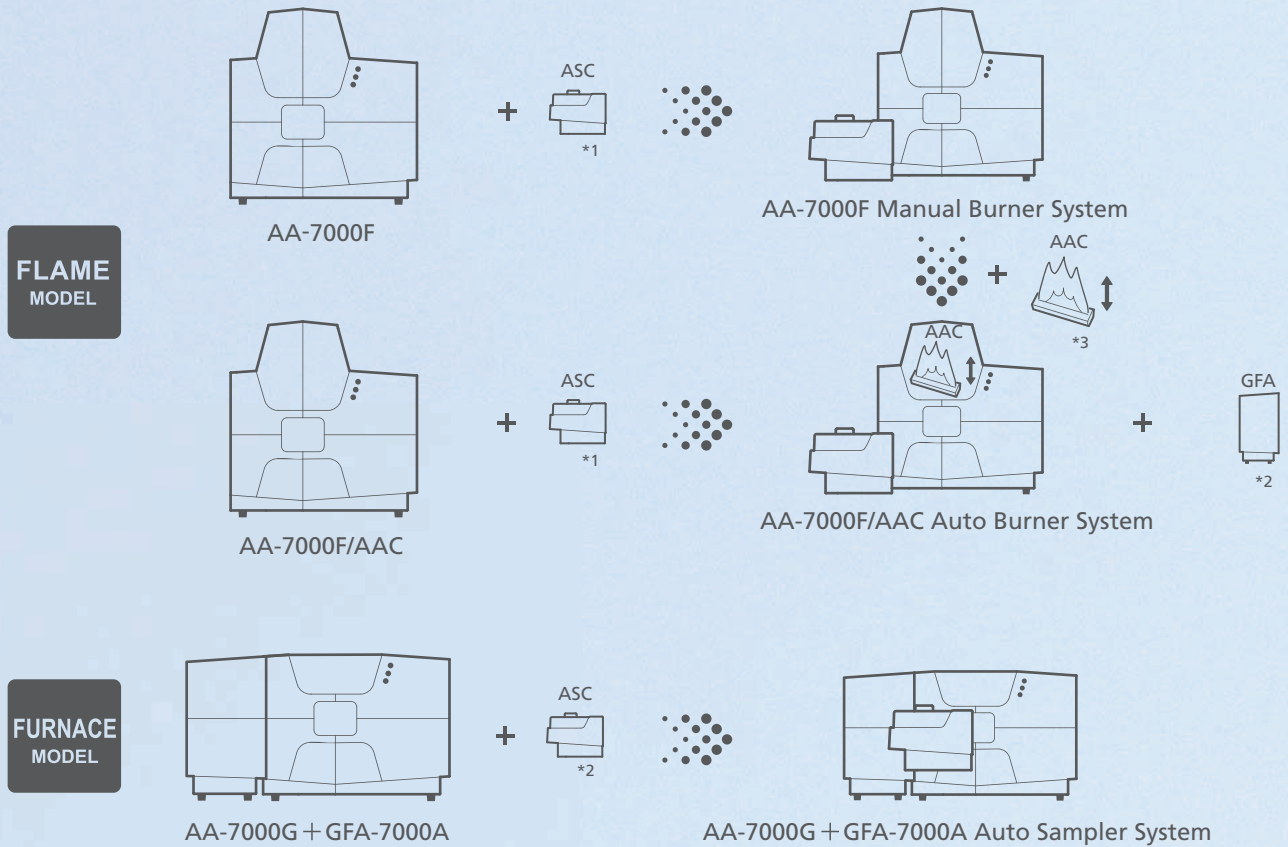

Major Fields of Application

AA-7000 Series supports a wide range of analysis applications.



Environment

Seawater, river water, effluent, sludge, air-borne dust



Metals, Semiconductors, Ceramics

Metals, minerals, glass, ceramics, IC chips



Petroleum, Chemicals, Polymers

Petroleum, oil, catalysts, chemical products, biodiesel



Medical, Biology, Pharmaceuticals

Blood, animals, plants, drugs, food products

Analysis Sensitivities

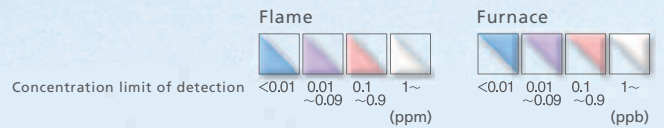

H																				He
Li	Be													B	C	N	O	F	Ne	
Na	Mg													Al	Si	P	S	Cl	Ar	
K	Ca	Sc	Ti	V	Cr	Mn	Fe	Co	Ni	Cu	Zn	Ga	Ge	As	Se	Br	Kr			
Rb	Sr	Y	Zr	Nb	Mo	Tc	Ru	Rh	Pd	Ag	Cd	In	Sn	Sb	Te	I	Xe			
Cs	Ba	La	Hf	Ta	W	Re	Os	Ir	Pt	Au	Hg	Tl	Pb	Bi	Po	At	Rn			
Fr	Ra	Ac																		
					Ce	Pr	Nd	Pm	Sm	Eu	Gd	Tb	Dy	Ho	Er	Tm	Yb	Lu		
					Th	Pa	U	Np	Pu	Am	Cm	Bk	Cf	Es	Fm	Md	No	Lr		

* May differ according to coexisting substances in the sample.

Enhanced Flame Analysis

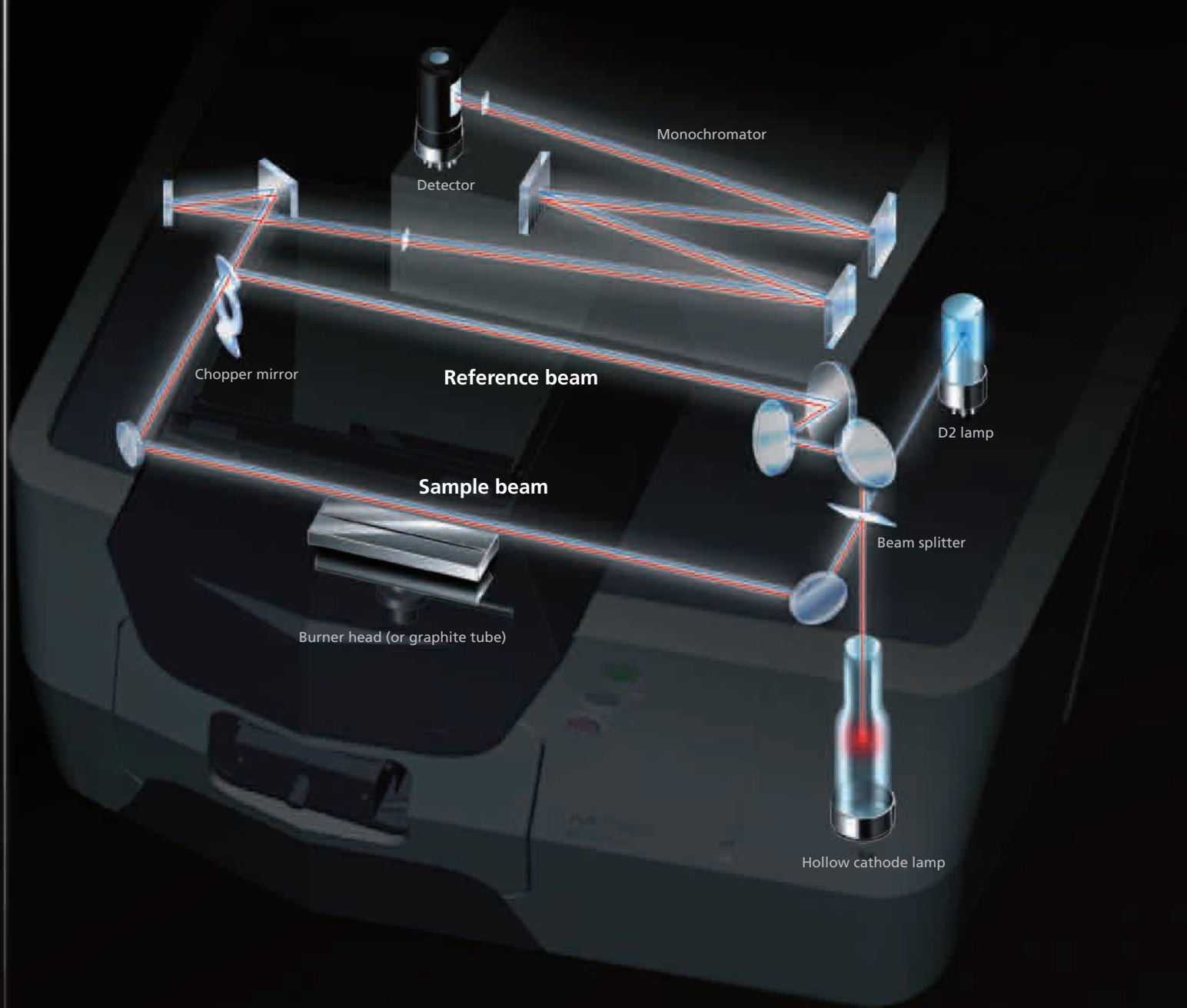

Double-Beam Optics and Stable Hardware Achieve Superior Stability

The AA-7000 Series incorporates newly developed 3D double-beam optics. The optical system has been designed to produce its maximum performance for each measurement method through optimal adjustment of the light beam and light beam digital filter, and by using optical components that restrict light losses.

Advantages of the Double-Beam System

■ Long-term stability

The graph shows the results of measurements on 2 ppm copper (Cu) conducted over at least one hour. (The plot shows mean values for 11 repeated measurements.) Over the course of more than 600 measurements, the instrument achieved a relative standard deviation within 1%.

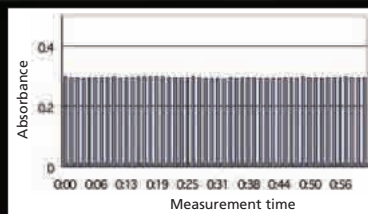

Data Showing Long-Term Stability for Flame Cu Measurements

■ High sensitivity

The graph shows the direct measurement results for 0.1 ppm lead (Pb).

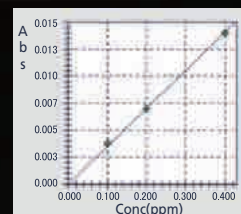

0.1 ppm to 0.4 ppm Calibration Curve for Lead (Pb)

Support for Developing Analytical Conditions

■ Automatic gas flow rate optimization

Automatic searching for optimal fuel gas flow rate (Japanese Patent 2099886). It is important to determine the optimal gas flow rate for the flame when using an organic solvent or after changing the burner height. The AA-7000F Series automatically optimizes the gas flow rate by measuring the changes in absorbance between a blank and a standard sample. The difference between the two is displayed on the screen. The gas flow rate achieving the highest sensitivity is detected and this value is automatically set as the gas flow rate value.

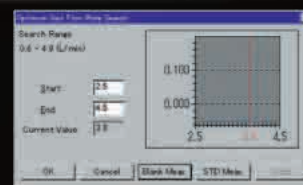

■ Automatic burner height optimization (AA-7000F/AAC)

The absorption sensitivity for flame analysis is also affected by the burner height. This results from variations in the flame temperature due to the burner height. The flame temperature is also affected by the matrix components. AA-7000F/AAC adjusts the burner height in 0.5 mm steps to automatically search for the optimal conditions. AA-7000F enables above function by AAC-7000 (option).

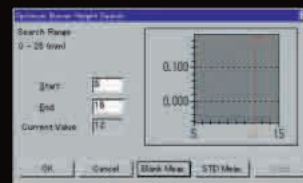

Optional Autosampler Reduces Analysis Workload

■ Low carryover

Great care must be taken to avoid carryover during flame analysis. The new ASC-7000 autosampler rinses the nozzle at the rinsing port on the overflow mechanism after each sample measurement is complete. This ensures 10^{-4} max. carryover during the measurements of multiple samples. The graph shows the results of consecutive analyses of 10 ppm, 20 ppm, and 50 ppm sodium (Na) standard solutions in the EMISSION mode. No carryover could be detected when measuring the 10 ppm standard sample immediately after the measuring the 50 ppm Na standard sample.

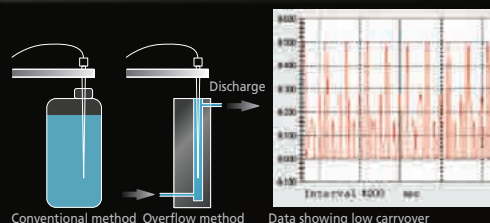

Trace Sample Analysis Using Micro Sampling

■ Micro sampling

At least 1 mL (1000 μ L) volume of a liquid sample is required for the continuous intake of sample during normal flame analysis. With micro sampling, however, approximately 50 to 90 μ L of sample is injected in one shot into the flame and quantitation is based on the height and area of the peak signal obtained. This method offers the advantages below.

Advantages

- Permits analysis of small sample volumes
- Multi-element analysis of small sample volumes
- No blockage of burner slot with samples having a high salt concentration
- Synchronized with the autosampler for auto-dilution measurements
- * Synchronization with the autosampler requires the optional micro sampling kit.

■ Example of micro sampling analysis

Examples of the measured waveforms (overlaid) and calibration curve for micro sampling analysis are shown to the right.

A 2-ppm Cu standard solution was prepared by auto-dilution using the autosampler. The autosampler can also be used to conduct dilution measurements of the sample. (Injection volume: 90 μ L)

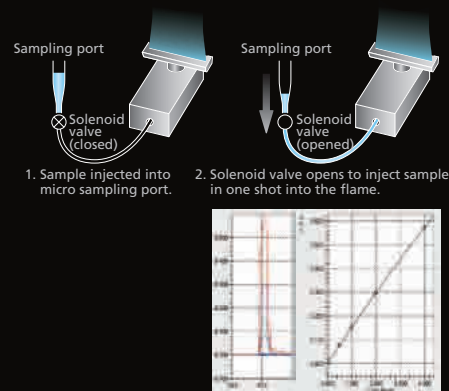

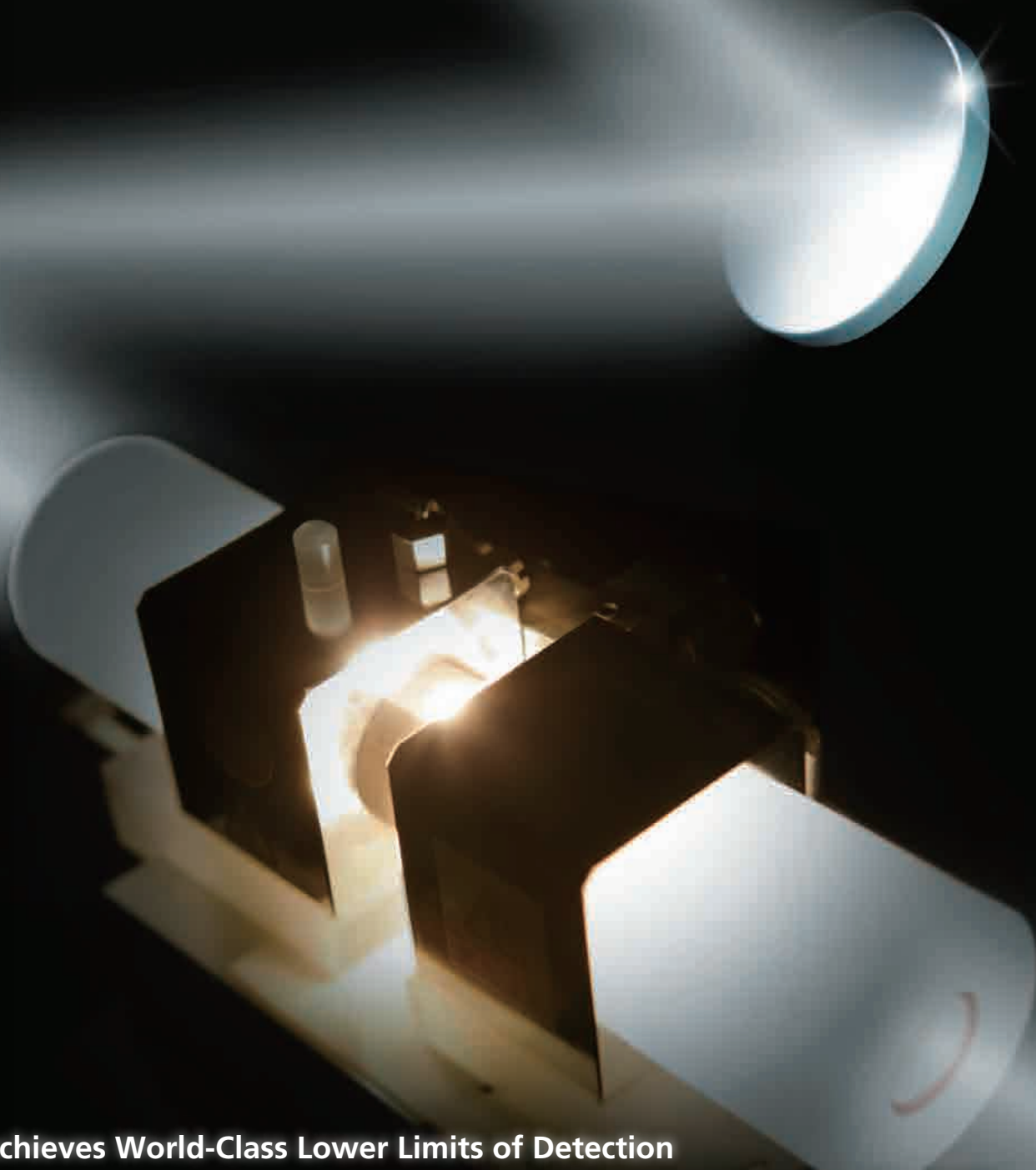

Achieves World-Class Lower Limits of Detection

Advances in optics and a new graphite furnace design achieve improved lower limits of detection for furnace analysis (comparison with previous Shimadzu models).

This superb analysis performance is possible in all fields.

Enhanced Sensitivity due to Graphite Furnace

	Previous		New
Pb	0.08ppb	▶	0.05ppb
Mn	0.02ppb	▶	0.01ppb

High-Performance Autosampler

- Mix and inject up to four sample types (diluted solution, standard solution, sample, matrix modifier, etc.). (Of course, unmixed samples can also be injected.)
- Select a fluororesin tube or pipette tip as the injection nozzle.
- Automatic dilution and re-analysis if the calibration curve concentration is exceeded.

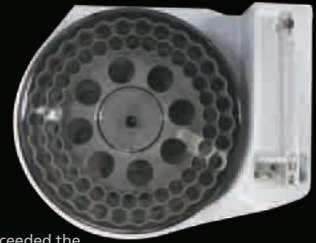

Example of Automatic Dilution and Re-Analysis

Analysis of cadmium (Cd): The maximum concentration of the calibration curve has been set to 1ppb. At 1.8ppb, the sample of [003] has exceeded the maximum concentration. As a result it has been automatically diluted by 4 times and re-measured.

Action	Sample ID	True Value (ppb)	Conc. (ppb)	Att.	Pos.	VOL	Diluent R1	Reagent R2	Total Volume	ASC DF	Actual Conc.	Actual Conc. Unit	Out of Control Remark
19	SPIKE1-A 001+0	0.2500	0.7661	0.3069	4	10	3	2	20		0.7661	ppb	
20	SPIKE1-A 001+0	0.2500	0.7558	0.3048	4	10	5	5	20		0.7558	ppb	
21													
22													
23													
24	UNK3-1 003		0.5231	0.2123	5	5	15	0	20	40000	2.0924	ppb	
25	UNK3-2 003		0.5047	0.2006	5	5	15	0	20	40000	2.0158	ppb	
26	UNK3-AV 003		0.5128	0.2086	5	5	15	0	20	4.000	2.0552	ppb	

High-Sensitivity Application Data (Analysis of Selenium (Se))

- Independent control of the gas flow through the graphite tube during atomization achieves extremely high-sensitivity measurements. (Japanese Patent 2067563)

Measurement Example Showing High Sensitivity

Analysis of 0 to 5 ppb selenium (Se): Sensitivity is adequate for 1 ppb measurements. (20 µL injected volume, Pd modifier, pyro-coated graphite tube)

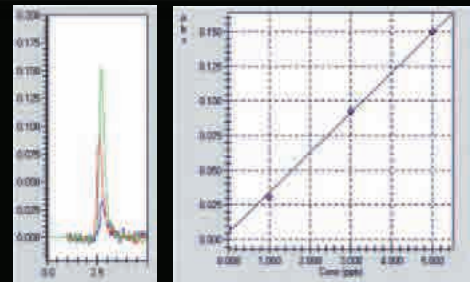

- Digital temperature control and electronic gas flow control enhance stability

Combination of a high-sensitivity optical sensor and unique digital temperature control technology achieves highly accurate temperature control in all temperature regions from drying to atomization. An electronic flow controller can precisely control the inner gas flow rate in 0.01 L/min units. These control techniques significantly enhance both the sensitivity and the data stability.

Measurement Example Showing High Stability

Analysis of 0.5 ppb lead (Pb): Approx. 5% relative standard deviation after 5 repeated measurements is adequate for quantitative analysis.

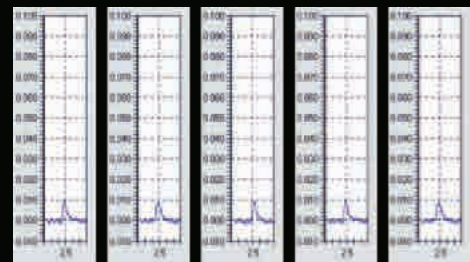

Selecting the Graphite Tube



High-density graphite tube (P/N 206-50587)

Can be used for all elements. Especially effective for low-boiling point elements (Cd, Pb, Na, K, Zn, Mg, etc.).



Pyro-coated graphite tube (P/N 206-50588)

Effective for elements that readily form carbides (Ni, Fe, Cu, Ca, Ti, Si, V, Mo, etc.).



Platform tube (P/N 206-50887-02)

Restricts chemical interference due to coexisting substances. Effective for the analysis of environmental samples and biosamples, such as sea water and industrial waste.

* Depending on the state of the sample, some other combinations may be appropriate.

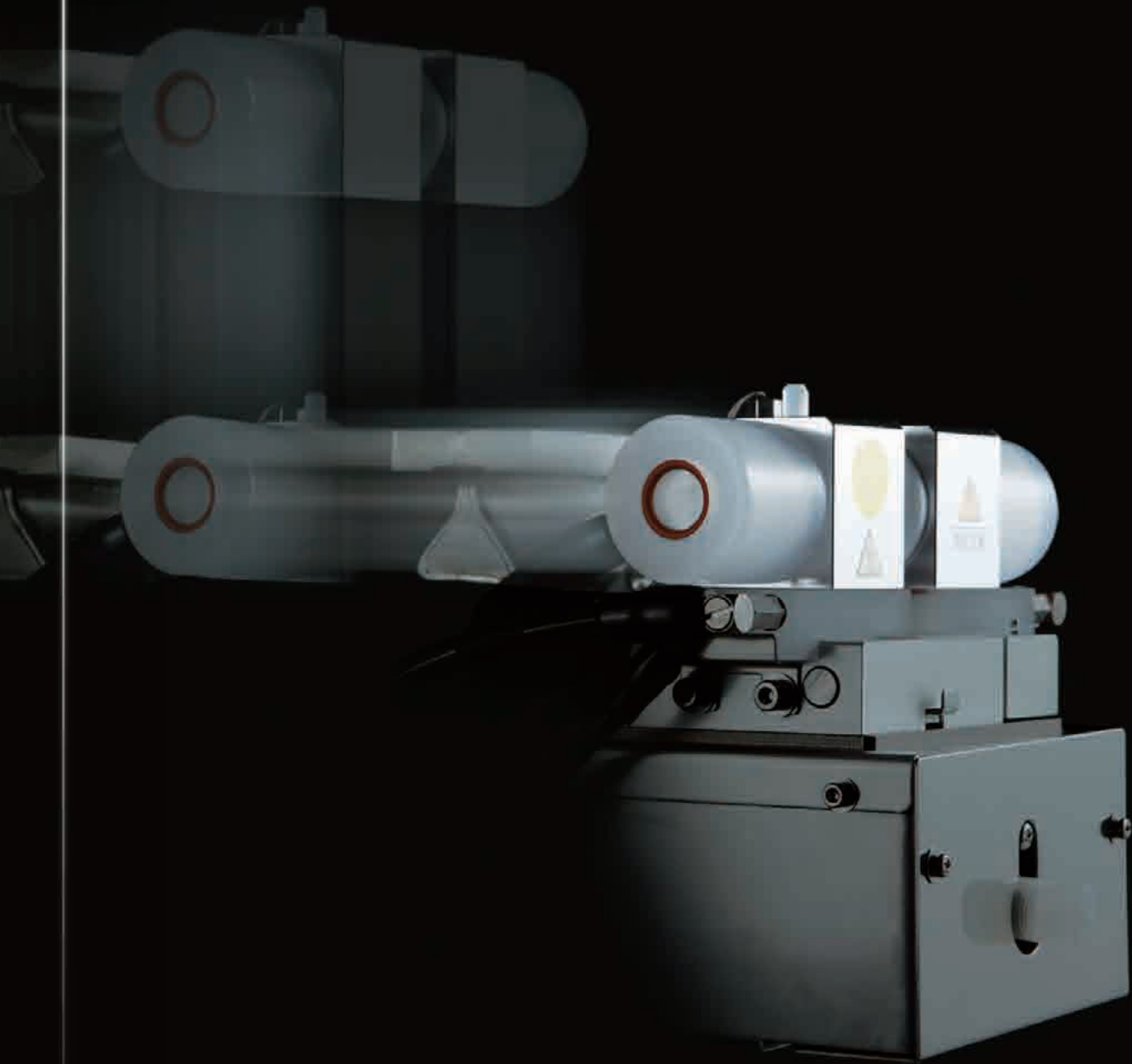

Single Unit Handles High Concentration to Trace Analysis Samples

AA-7000F/AAC creates an integral burner and furnace that remains permanently installed in the combustion chamber. It supports both flame analysis of high concentration samples and furnace analysis of trace samples, without changing the atomizer unit. The integral construction with the atomizer saves space.

AA-7000F enables above function by AAC-7000 (option).

* The AAC-7000 cannot be attached to an AA-7000G instrument.

New Atomizer Design Permits Easy Switching Between Flame and Furnace Measurements

- The new drive mechanism halves the switching time between flame and furnace measurements (comparison with previous Shimadzu models).
- The atomizer unit is switched automatically by software operation. No troublesome replacement of the atomizer unit is required. No need to disconnect pipes or wires.
- In case of the flame measurement of high-concentration sample, offsetting the burner head from the light axis, instead of angle adjustment, allows to adjust the sensitivity.
- A single autosampler can be used for both flame and furnace measurements. Simply slide it left or right. No need to purchase two autosamplers.

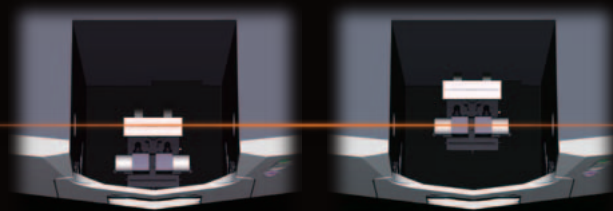

Flame measurement: Burner head intersects the light axis (red line).

Furnace measurement: Furnace intersects the light axis (red line).



Flame measurement

Furnace measurement

Slim, Easy-to-Use Design

■ Smallest footprint for a full system

The system with a dual atomizer fits into a 960 mm width (including power supply for the graphite furnace atomizer), achieving the world's smallest installation footprint* for a full system.

* Shimadzu in-house investigation. Current as of November 2008.

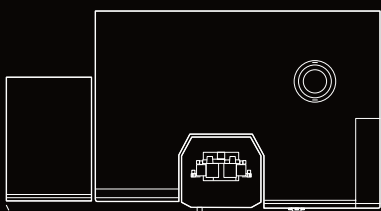

AA-6300
1090 (W) × 545 (D) × 460 (H) mm

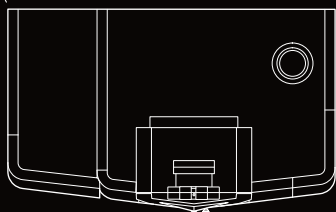

AA-7000F/AAC Dual Atomizer System
960 (W) × 588 (D) × 714 (H) mm

* Dimensions do not include ASC-7000. Height (H) does not include protrusions.

■ Easily attach an autosampler

Direct connection of the autosampler to the AA instrument minimizes the installation footprint and simplifies maintenance.



■ Lamp house

Just slide the cover to the side for easy replacement of the hollow cathode lamps through the large opening.





Comprehensive Safety Functions in Every System

Safety is an extremely important consideration for flame atomic absorption spectrophotometers using acetylene gas. The AA-7000 Series instruments are the first* ones in the world fitted with a vibration sensor as standard. They also incorporate a comprehensive range of safety mechanisms, including gas leak detectors.

* Shimadzu in-house investigation. Current as of November 2008.

Safety Functions for Flame-Specification Instruments

■ World first! — flame extinguished automatically by vibration sensor

The flame is automatically extinguished when the new built-in sensor detects vibrations. Instruments are completely safe during severe shaking caused by earthquakes.



■ Multimode automatic gas leak check

The fuel gas pipes inside the instrument gas controller are automatically checked for gas leaks when the power is turned on and when the flame is extinguished. Should a gas leak be detected, a warning buzzer sounds and a warning is displayed on the screen.

■ Automatic flame ignition and extinguishing

Flame ignition and extinguishing operations are extremely simple. The Air-C₂H₂ flame priority ignition mechanism prevents flashback.

■ Automatic Air-N₂O switching system with acetylene flow-rate monitor

After the ignition of an Air-C₂H₂ flame, the flame automatically switches to an N₂O-C₂H₂ flame.

If the C₂H₂ flow rate does not increase due to solenoid valve trouble, for example, switching to the support gas is disabled to prevent flashback.

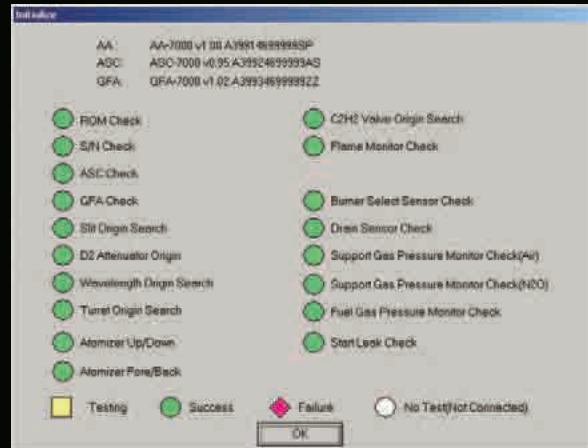

The connected options and operation of safety mechanisms are checked during instrument initialization.

■ Pressure monitor prevents flashback

■ Automatic gas shut-off by flame monitor

■ Sudden power interruption detection and re-ignition safety measures

■ Mechanism to prevent misuse of the burner

■ Drain tank level monitor

Safety Functions for Furnace-Specification Instruments

■ Cooling water flow rate monitor

■ Argon gas pressure monitor

■ Furnace cooling check

■ Overcurrent protection unit (double-checked by circuit protector and optical sensor)

Safety-Conscious Design

■ Flame-retardant materials

UL 94V-0-rated flame-retardant materials are used for the instrument external covers and atomizer unit. This superior design pays due consideration to safety.

■ Safe ignition switches

The switches perfectly fit finger contours and are positioned near the window.

To prevent inadvertent operation, both switches must be pressed simultaneously to start ignition.



■ Durable pipes and reliable couplings

All pipes are selected for durability and used with highly reliable couplings.

■ Clear window

The large window permits observation of the flame, and the burner can be easily accessed through the large opening. The window closes when released to eliminate the chance of it being left open.



The optimal background correction methods are installed as standard: high-speed self-reversal method (SR method) and deuterium lamp method (D₂ method).

These functions can correct for spectral interference in flame measurement. Selecting the optimal background correction method for each sample ensures accurate and reliable analysis results.

Samples suitable for the SR method

Samples with a complex matrix
(Containing a large quantity of a specific element as the main component)

Samples suitable for the D₂ method

Purified water, tap water, environmental water, etc.
Samples with a relatively simple matrix

SR (high-speed self-reversal) method — accurate background correction over a wide range

Features

1. High-speed self-reversal (SR) correction is generally more accurate than deuterium lamp (D₂) correction. As both atomic absorption and background absorption can be measured using a single lamp, the correction errors due to light-axis misalignment are extremely small. This is ideal for the quantitation of trace components in a matrix exhibiting complex background absorption, such as bio-samples and metals.
2. Permits background correction over the entire wavelength range from 185 nm to 900 nm.
3. This method can correct for spectral interference due to neighboring lines that can occur when a resonance line for another element exists near the analytical line for the target element. (See table on next page.)
4. As no polarizer is used, measurements are possible with low light losses and a high S/N ratio.
5. The rapid lamp lighting permits accurate measurement unaffected by emission noise in the atomizer.

* Hollow cathode lamp L-2433 is required to use the SR method. Hollow cathode lamp L-2433 can also be used for the D₂ method.

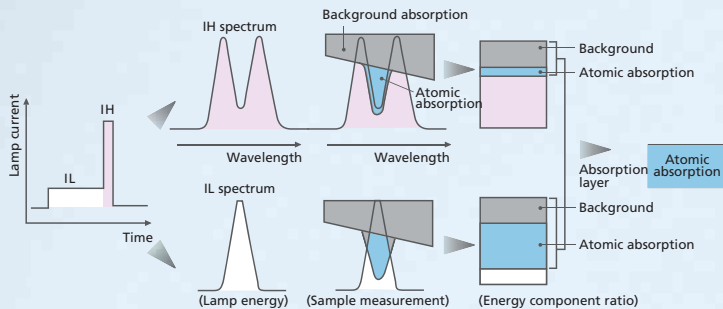

Principle

A small current IL (approx. 10 mA) and a large current IH (approx. 500 mA) are alternately passed through the hollow cathode lamp. The lamp emission spectrum when the large current flows has a depression in the center (self-reverse), due to self-absorption of the large number of sputtered atoms in the atom cloud, as shown in the diagram to the left. No significant atomic absorption is apparent and background absorption mainly occurs. Conversely, the lamp emission spectrum when the small current flows comprises a single narrow peak resulting from both atomic absorption and background absorption. By determining the difference between the two types of absorption, it is possible to accurately correct for the background absorption and measure the true atomic absorption.

Examples suitable for SR method (where differences result between SR and D₂ methods)

Example: Measurement of trace levels of zinc in iron (analysis of Zn in Fe solution)

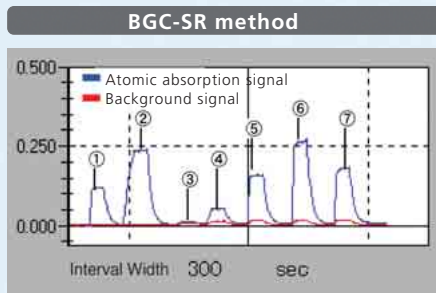

The identical 0.5 ppm Zn solution is accurately corrected to the same absorbance at (2) and (6).

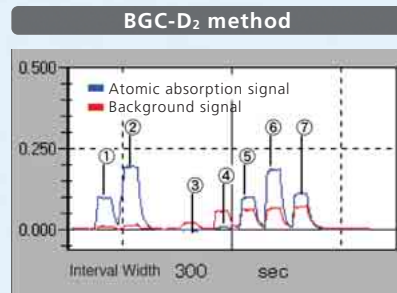

Due to inadequate correction, the absorbance is higher at (6) than at (2) for the identical 0.5 ppm Zn solution.

- ① Zn 0.25ppm
- ② Zn 0.50ppm
- ③ Fe 0.1%
- ④ Fe 0.5%
- ⑤ Fe 0.5% + Zn 0.25ppm
- ⑥ Fe 0.5% + Zn 0.5ppm
- ⑦ Fe 0.75% + Zn 0.3ppm

Examples of elements and wavelengths causing spectral interference problems due to neighboring lines

Measured Element	Analytical Line (nm)	Coexisting Element	Absorption Line (nm)
Al	309.28	Mg	309.30
As	193.76	Fe	193.73
Ca	422.67	Fe	422.64
Cd	228.80	Ni	228.84
Cu	324.75	Fe	324.73
Ga	294.36	Ni	294.39
Mg	285.21	Fe	285.18
Ni	232.00	Fe	232.04
Pb	217.00	Fe	216.95
Sb	217.58	Fe	217.55
Se	196.03	Fe	196.05
Si	251.61	Fe	251.69
Zn	213.856	Fe	213.8589

The SR method is suitable for samples containing elements that cause problems with spectral interference, as shown in the table to the left.

D₂ (deuterium lamp) method — highly sensitive background correction

Features

1. Detection sensitivity is superior to the SR method. Therefore, this method is suitable for the analysis of samples with a simple matrix requiring high sensitivity, such as the measurement of trace levels of impurities in ultrapure water or environmental analyses.
2. As the lighting frequency is higher than with the SR method, it can eliminate noise due to emission components of the flame or graphite tube to permit accurate atomic absorption measurements.
3. The original hollow cathode lamp can be used.

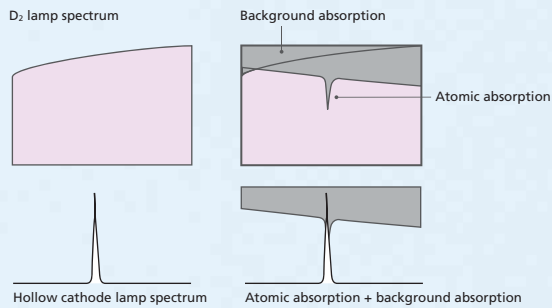

Principle

The deuterium lamp method involves lighting the hollow cathode lamp and the deuterium lamp alternately at high speed. After separation by the monochromator, the light from the deuterium lamp has a bandwidth from 0.1 to 5 nm. Therefore, an atomic absorption with a line width of only about 1/1000 nm is almost unobservable compared to the background absorption due to wide-bandwidth molecular absorption. However, as the light from the hollow cathode lamp has approximately the same bandwidth as the atomic absorption band, the total of the atomic absorption and the background absorption can be observed. With the deuterium lamp (D₂) method, light from both sources passes through the atomizer. The difference in absorbance is determined to conduct background correction.

Examples suitable for D₂ method (where no difference results between SR and D₂ methods)

Example: Measurement of trace levels of lead in 2% NaCl solution by molecular absorption (analysis of Pb in 2% NaCl solution)

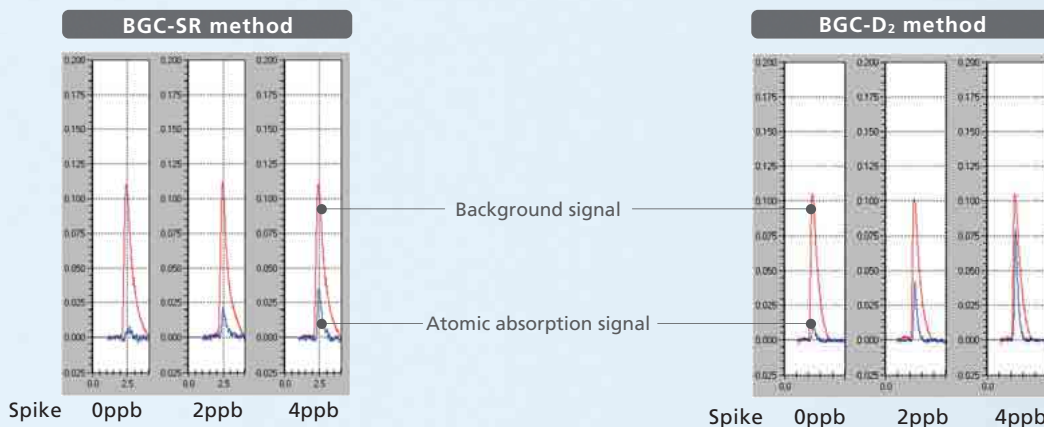

It can be seen that the sensitivity is higher with the BGC-D₂ method.

Clear, Easy-to-Use Software

Features of the WizAard Software

The WizAard software used with the AA-7000 runs under Windows 7/ Vista/XP.

Wizard Functions Make Setting the Conditions So Simple That Even a Novice Can Do It.

Just set the measurement conditions using WizAard to complete the general settings.

The initial settings can also be completed simply by following the Wizard procedures.



Measurement Screen Layout Shows Measurement Status at a Glance

Measured element

Real-time signal monitor

Signal profile display

Calibration curve display

MRT (Measured Results Table)
The worksheet shows sample names, absorbance, concentrations, and correction calibration results.

Lamp History Function Assists with Lamp Management

The accumulated operation time for each lamp displayed on the lamp registration screen assists with lamp service life management. Multiple lamps for the same element are differentiated using lamp IDs.

Lamp ID	Element	Lamp Type	Lamp Type	Unit	Unit	Judge	Comment	Lock
1	Ca	Ca	Normal	5000	0.0	Pass	OK	
2	Ag-1	Ag	Normal	5000	0.0	Pass	OK	
3	AJ-1	AJ	Normal	5000	0.0	Pass	OK	
4	As-1	As	Normal	5000	0.0	Pass	OK	
5	Au-1	Au	Normal	5000	0.0	Pass	OK	
6	Ba-1	Ba	Normal	5000	0.0	Pass	OK	
7	Ba-1	Ba	Normal	5000	0.0	Pass	OK	
8	Be-1	Be	Normal	5000	0.0	Pass	OK	
9	Ba-1	Ba	Normal	5000	0.0	Pass	OK	
10	Ca-1	Ca	Normal	5000	0.0	Pass	OK	
11	Ca-1	Ca	Normal	5000	0.0	Pass	OK	
12	Ca-1	Ca	Normal	5000	0.0	Pass	OK	
13	Ca-1	Ca	Normal	5000	0.0	Pass	OK	
14	Ca-1	Ca	Normal	5000	0.0	Pass	OK	
15	Ca-1	Ca	Normal	5000	0.0	Pass	OK	

Software Provides Comprehensive Information Displays and Flexible Settings

Identical software operation for flame and furnace measurements

- 1 Even if the calibration curve is created after sample measurements, concentration calculations can be conducted on past data. This allows trial measurements to be directly used as actual measurements.
- 2 Extrapolation of calibration curve range. If the sample concentration exceeds the calibration curve range, additional measurements can be performed on standard solutions to re-calculate the concentration.
- 3 Use existing calibration curves for measurements. Useful for sample concentration order checks and for checking the instrument sensitivity.
- 4 One-touch re-measurement operation. No need to repeat the measurement from the beginning.
- 5 Create and save multiple calibration curves on a single worksheet. Select the appropriate calibration curve for the sample concentration and composition.

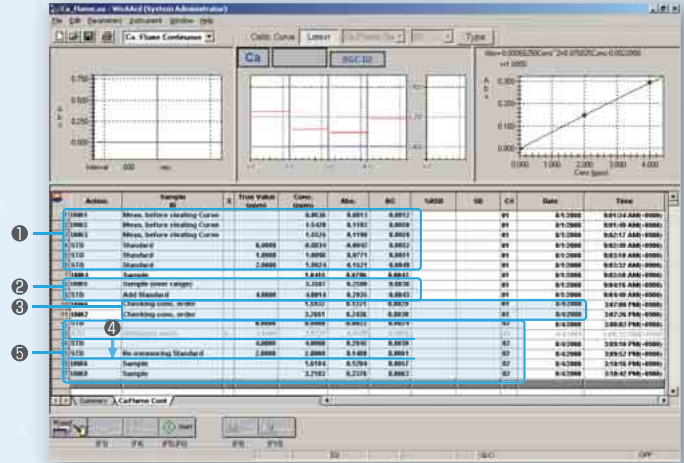

Combining a high-performance autosampler simplifies advanced settings

- 1 Real-time drying and ashing progress display for furnace measurement
- 2 A higher temperature cleaning operation than the cleaning stage can be added for each measurement. This reduces the graphite tube memory effect. Tube deterioration is reduced by minimizing the cleaning operations.
- 3 Add optional autosampler rinsing operations to ensure adequate rinsing of the autosampler after completing the measurement of high-concentration samples.
- 4 Set up sample dilution and spike-and-recovery tests on the same screen.
- 5 Overlay function allows size and shape comparison of peak profiles.
- 6 Large-volume injection permits high-sensitivity measurements.
- 7 Precision control of drying and ashing temperatures reduces analysis time.

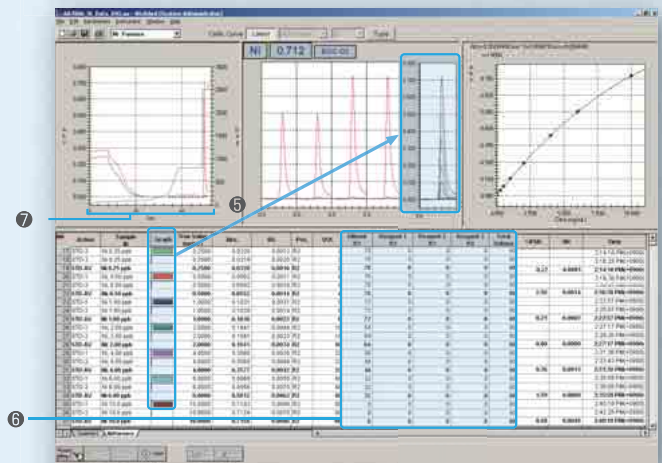
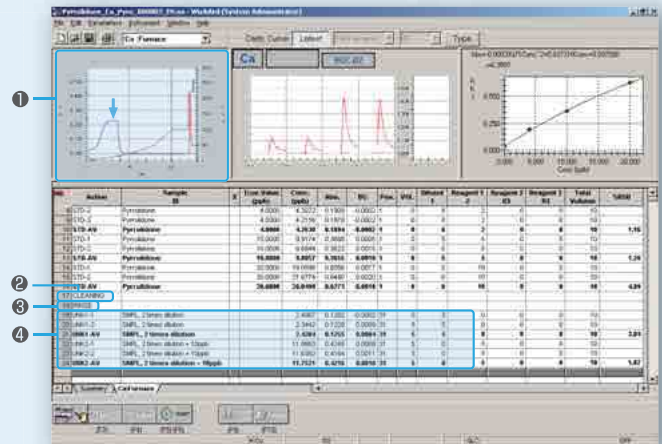

FDA 21 CFR Part 11 Compliance

- A combination of enhanced WizAard software with Shimadzu's network-compatible CLASS-Agent data management software supports FDA 21 CFR Part 11 Compliance.
- WizAard used alone provides comprehensive system policy setting, user management, log browser, audit trail, and electronic signature system management functions.
- Hardware validation software installed as standard.

Comprehensive Data Management Functions

System Policy

The system policy settings allow advanced password and lockout settings. The levels can be set in stages from "unrestricted" to "Part 11 compatible".

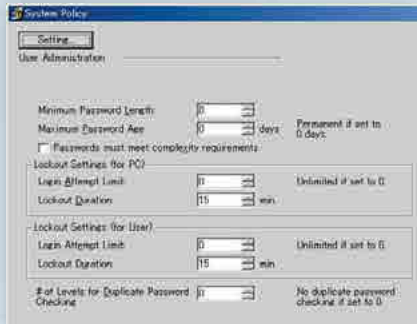

CLASS-Agent (Option)

Connection to CLASS-Agent permits efficient, long-term database management of large amounts of analysis data.

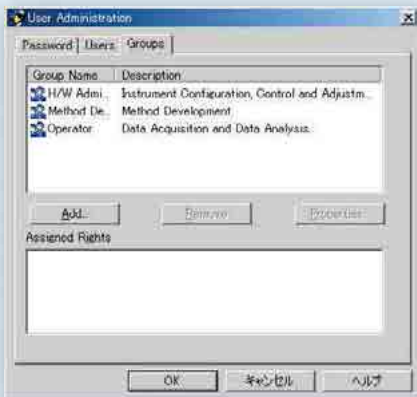

User Management

User management restricts the users of the system. It registers each user to determine how each one uses the software.



Log Browser

The log browser easily displays a variety of logs to check the system modification history and other log information.

Management

Accuracy Management (QA/QC) Functions Permit User Level Management, Audit Trail, and Electronic Signatures

■ QA/QC compatibility

The QA/QC functions permit accuracy management.

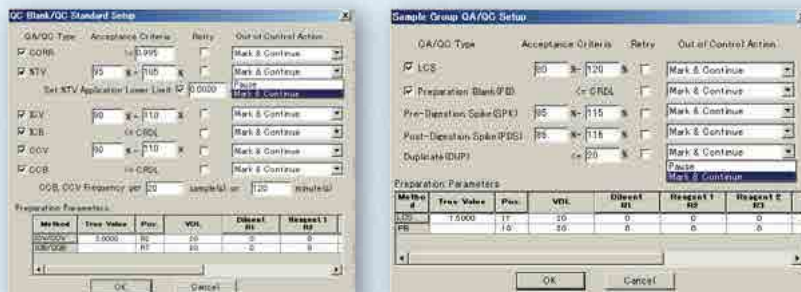

■ Hardware validation software installed as standard

The hardware validation software makes it simple to evaluate the instrument performance. When combined with the autosampler, it automatically determines the wavelength accuracy, noise level, baseline drift, absorbance and repeatability, and prints out the results of comparison with the pass criteria.

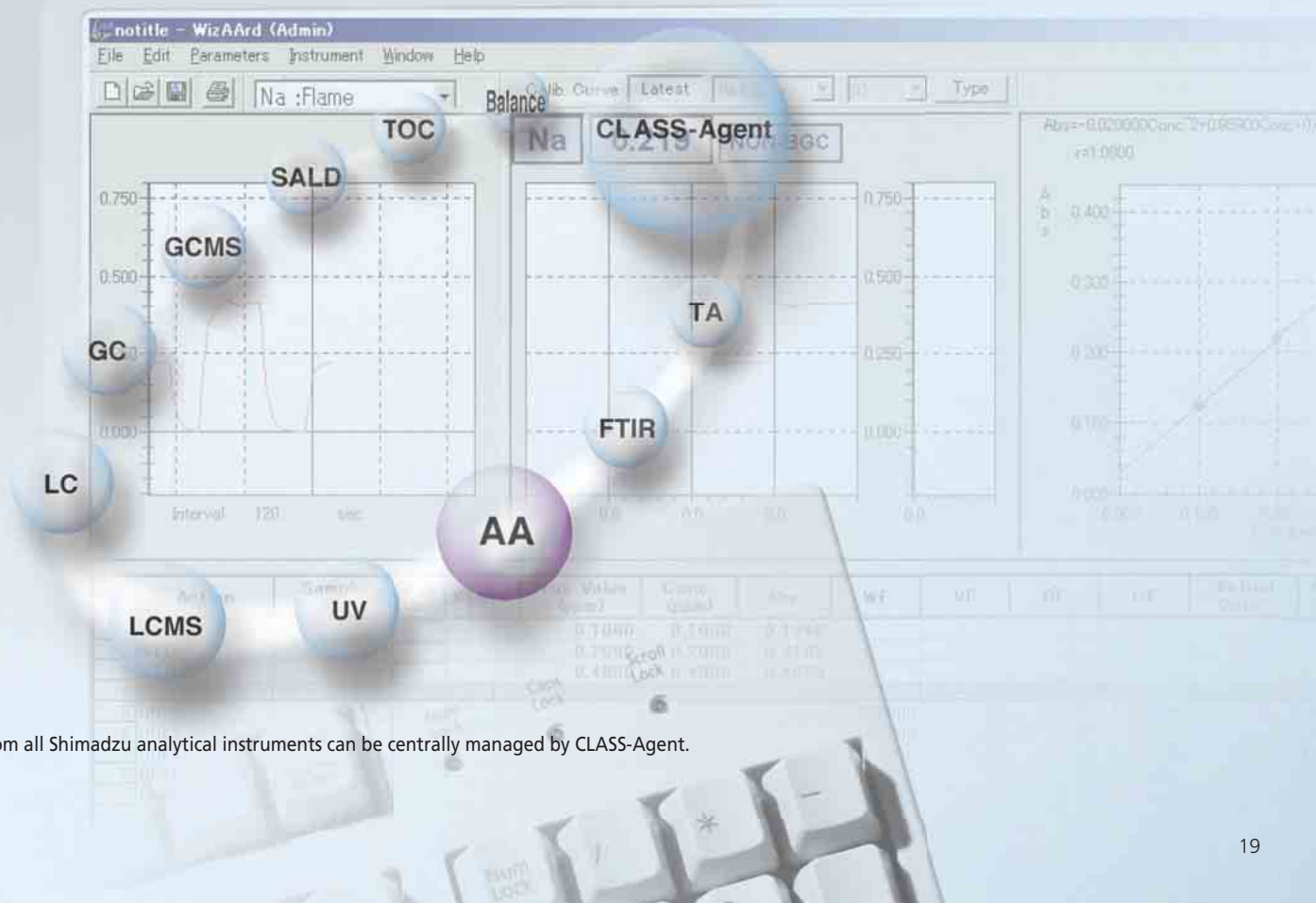

* Data from all Shimadzu analytical instruments can be centrally managed by CLASS-Agent.

Common to All AA-7000 Series Models

Part Name	Quantity	P/N
Cable set	1	071-60821-08 (120 V), 071-60825-51 (230 V)
Cards (set of 10)	1	206-52046-91
Instruction manual	1	206-97176
Safety inspection sheet (safety instruction)	1	206-97225
Declaration of conformity, explanatory notes (ISO-9001)	1	228-30164
Warranty label	1	037-70238-01
Registration form	1	221-40500
Serial number label	3	206-57770

* The PC, monitor, printer, hollow cathode lamps, high-temperature burner head, pressure regulator and compressor are not included in the standard configuration.

AA-7000F, AA-7000F/AAC Standard Parts List

Part Name	Quantity	P/N
Hose ASSY (for air supply)	1	206-50389-91
Hose ASSY (for C ₂ H ₂ gas supply)	1	206-50389-92
Hose clamp (16 mm)	2	037-61019
Cleaning wire	1	201-79229-01
Sampling tube (PTFE)	2	204-05899-01
Sampling tube (for organic solvent samples)	1	206-50772-91
Polyethylene tubing, No. 3	1 (0.3 m)	200-31328-01
Polyethylene tubing, 8 × 1 (drain tubing)	1 (2.4 m)	016-43201-02
Drain ASSY	1	206-77413-41
Grease (in cup)	1	206-50442-91
Funnel	1	206-77243-92
Declaration of conformity, English version (ISO-9001)	1	206-84934-66/-68
Inspection report	1	206-77551-02/-22

AA-7000G Standard Parts List

Part Name	Quantity	P/N
Declaration of conformity, English version (ISO-9001)	1	206-84934-67
Furnace mounting plate	1	206-77704
Inspection report	1	206-77551-12

* GFA-7000A is not included in the standard configuration.

Personal Computer / Monitor

Operating system	Microsoft Windows 7 Professional (32 bit) Vista Business or XP Professional
CPU	Intel® Celeron 420 (1.60 GHz) or higher
RAM	1 GB or higher (Vista) or 512 MB or higher (XP)
Monitor	XGA (1024 × 768 dots) or higher
Storage device	One CD-ROM drive (for installing software) Requires 60 MB min. hard disk space for installation
I/O port	One serial port (for AA control)

* Windows is a registered trademark of Microsoft Corp., U.S.A.

Optional Accessories



For Flame Analysis

Part Name	P/N	Remarks
High-temperature burner head	206-77530-91	Made of pure titanium. Air-cooled. 5 cm slot for N ₂ O-C ₂ H ₂ flame <ul style="list-style-type: none"> • Extremely corrosion-resistant • Can also be used for Air-C₂H₂ flame.
		
Flow meter kit	206-77617-41	Float-type flow meter for support gas
Sample platform	206-77655-91	Dimensions: 250 W × 130 D × 170 H mm Vial mounting platform: 220 W × 95 D mm Vial positions: 5-step switching
Air compressor	208-91753-91	100 VAC, 50/60 Hz, with mist separator
Low-noise air compressor	208-91750-36	100 VAC, 50/60 Hz, with mist separator
Mist separator kit	206-52458-91	Required if using an air compressor other than above.
YR-71 compressed gas regulator	040-72020-01	For C ₂ H ₂
MAF-85S compressed gas regulator	040-72019-11	For dinitrogen oxide gas
Micro sampling kit	206-77540-91	Required to use the flame micro sampling method. ASC-7000 and ASK-7000 (or ASC stand kit) are also required.
O-ring set	206-77620-92	O-ring set for organic solvents

For Furnace Analysis

Part Name	P/N	Remarks
GFA-7000A graphite furnace atomizer	206-77777-XX	<ul style="list-style-type: none"> ■ Specifications Heating control system: Drying: Digital current control (with automatic temperature calibration function) Ashing, atomization: Digital temperature control via optical sensor Heating temperature range: Ambient to 3000 °C Inner gas type: Dual automatic switching type Inner gas flow rate: 0 to 1.50 L/min, 0.01 L/min increments Ar gas: 3.5 L/min max. Cooling water: Cooling water circulation unit or tap for process water Water temperature: 10 to 30 °C, flow rate: 0.6 to 1.5 L/min * Separately order the parts below.
		
Graphite Furnace Camera GFA-TV	206-52950-41	Provides viewing inside the graphite tube. Including Video View Software (CD-ROM)
High-density graphite tube	206-50587-11	Select one of the three types of graphite tubes according to the aim of the analysis.
Pyro-coated graphite tube	206-50588-11	
Platform tube	206-50887-02	
MAF-106S compressed gas regulator	040-72019-21	For Argon gas
CA-1115A-1 cooling water circulation unit	044-01813-01	For cooling GFA, 100 VAC, 1100VA, 50/60 Hz
Parts for cooling water connections		
Cooler connection kit	206-84373-41	For connecting GFA and CA-1115A-1
Cooling water tube ASSY	206-51028-41	Connecting tubes when using tap water to cool GFA
Regulator ASSY	206-86147-41	Decompression valve when using tap water to cool GFA

Autosampler

Part Name	P/N	Remarks
ASC-7000 autosampler	206-77600-XX	<ul style="list-style-type: none"> ■ Specifications System: Flame / furnace Function: Zero-point detection, auto rinse, auto diagnosis, random access Maximum reagent / sample positions: Reagents: 8 positions, samples: 60 positions * Separately order the parts below.
 		
ASC stand kit	206-77650-41	Required to mount ASC-7000 to conduct flame analysis only.
ASK-7000 extension unit for furnace analysis	206-77550-41	Permits both flame and furnace analysis.
Nozzle ASSY, HVG	206-67563	Required to use ASC-7000 and HVG-1.

Dual Atomizer System

Part Name	P/N	Remarks
AAC-7000 auto atomizer changer	206-77701-41	Required to add GFA-7000A to AA-7000F to conduct furnace analysis. Permits automatic burner position setting for flame analysis with AA-7000F.

Hollow Cathode Lamps

Part Name	P/N	Remarks
L-233 series	200-38422-XX	
L-2433 series	200-38456-XX	For SR method

Other Accessories

Part Name	P/N	Remarks
Analog output cable	206-77707-91	Used for analog output to a pen recorder, etc. One cable required per channel (atomic absorption/energy signal, background signal).

For High-Sensitivity As, Se, Sb Analysis

Part Name	P/N	Remarks
HVG-1 hydride vapor generator	206-17143-XX	<p>Environmental standards prescribe the hydride generation method as one method of As, Se, and Sb analysis.</p> <ol style="list-style-type: none"> Used with the AA-7000 Series, HVG-1 permits the rapid and accurate quantitation of elements such as As, Se, Sb and Hg at several-ppb levels. Used with an ASC-7000 autosampler, it permits the automated serial analysis of up to 60 samples. <p>* Nozzle ASSY, HVG (P/N: 206-67563) is required to use HVG-1 with an ASC-7000 Series instrument. Order separately.</p> <p>■ Specifications Measurement method: continuous flow Sample consumption: 0 to 7 mL/min, variable Reagent consumption: 0 to 2.5 mL/min, variable Atomizer: Heated absorption cell (heated by Air-C₂H₂ flame in standard system) Carrier gas: Ar pressure: 0.32 MPa, consumption: 70 mL/min Power requirements: 100, 120, 220, 230, 240 VAC, 35 VA, 50/60 Hz Dimensions: 340 W × 220 D × 200 H mm Weight: Approx. 9 kg</p> <p>■ Standard Major Items Hydride vapor generator, absorption cell (P/N: 206-77607) Reagent bottles (P/N: 206-58792-40/-42), gas hose, drain tube, etc.</p>



For Higher Sensitivity with the Hydride Generation Method

Part Name	P/N	Remarks				
SARF-16C atomic muffle furnace (Electronic Cell Heater)	208-97249	<ol style="list-style-type: none"> This dedicated furnace permits higher sensitivity measurements using the hydride vapor generator than the flame heating method. The temperature controller provides optimal control of the quartz cell temperature. Good temperature reproducibility. Extends cell life by preventing damage due to overheating. <p>* The atomic muffle cannot be used when an AAC-7000 is installed on an AA-7000F/AAC or AA-7000F.</p> <p>■ Specifications</p> <table border="1"> <tr> <td>Furnace</td> <td>Dimensions: 170 W × 110 D × 110 H mm I.D.: ø25 × 170 mm Heater: PYROMAX DS</td> </tr> <tr> <td>Controller</td> <td>Operational temperature range: Ambient to 1100 °C Temperature regulation range: ±2.5 °C Load capacity: 1000 W max. Power requirements: 100 VAC, 400 VA, 50/60 Hz</td> </tr> </table> <p>* Use a stepdown transformer in regions that do not have a 100 V power supply.</p>	Furnace	Dimensions: 170 W × 110 D × 110 H mm I.D.: ø25 × 170 mm Heater: PYROMAX DS	Controller	Operational temperature range: Ambient to 1100 °C Temperature regulation range: ±2.5 °C Load capacity: 1000 W max. Power requirements: 100 VAC, 400 VA, 50/60 Hz
Furnace	Dimensions: 170 W × 110 D × 110 H mm I.D.: ø25 × 170 mm Heater: PYROMAX DS					
Controller	Operational temperature range: Ambient to 1100 °C Temperature regulation range: ±2.5 °C Load capacity: 1000 W max. Power requirements: 100 VAC, 400 VA, 50/60 Hz					
Mounting adaptor	206-52135-91	For AA-7000F				
	206-83755-91	For AA-7000G				

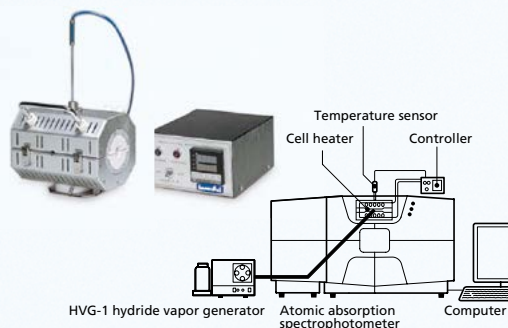

For High-Sensitivity Hg Analysis

Part Name	P/N	Remarks
MVU-1A mercury vaporizer unit	206-58780-XX	<p>This mercury vaporizer unit permits analysis using the reduction vaporization — atomic absorption method. It permits easy, high-sensitivity water quality analysis.</p> <p>■ Specifications</p> <p>Vaporization method: reduction vaporization with a reducing agent Measurement method: recirculation Flow cell: optical path length 100 mm (with quartz window) Sample volume: 250 mL max. Exhaust contamination prevention: adsorption trapping in mercury trap bottle Dimensions: 310 W × 357 D × 288 H mm Weight: Approx. 10 kg</p> <p>■ Standard Major Items</p> <p>MVU-1A unit: 1 Reaction vial (P/N: 200-93018-01): 5 Reaction vial lid (P/N: 204-21989): 2 Stirrer tip (P/N: 046-00617-06): 10 Mercury trap bottle (P/N: 206-58777-42): 1</p> <p>* Separately order the parts below.</p> <ul style="list-style-type: none"> • Gas flow cell (P/N: 201-98687) • Holder for gas flow cell (P/N: 206-77703-91) • Hg hollow cathode lamp (P/N: 200-38422-28)



ICP Emission Spectrometers

ICPE-9800 Series	Remarks
	<p>ICPE-9800 Series of simultaneous ICP atomic emission spectrometers offer the superior accuracy necessary to simultaneously and quickly analyze multiple elements regardless of their concentration levels. They also feature user-friendly software that makes analysis easy. Various assistant functions enable easy optimization of methods and a simpler, more efficient analytical workflow.</p> <p>Features</p> <p>Eco mode, Mini-torch system, Vacuum spectrometer: reduce the argon gas consumption Vertical torch orientation: ensure stable low-maintenance analyses 1-inch CCD detector: capable of simultaneous recording of all wavelengths</p>

Main Unit

Basics

Optics	Wavelength range	185.0 to 900.0 nm
	Monochromator	Aberration-corrected Czerny-Turner mounting, Number of grating grooves: 1800 lines / mm, Focal length: 300 mm
	Bandwidth	0.2, 0.7, 1.3, 2.0L nm (4-step automatic switching)
	Detector	Photomultiplier tube
	Optics	Optical double-beam
	Background correction method	<ul style="list-style-type: none"> ●BGC-SR (high-speed self-reversal method) (185.0 to 900.0 nm) ●BGC-D2 (D₂ lamp method) (185.0 to 430.0 nm)
	Number of HC lamps	6-lamp turret, 2 lamps simultaneously lit (1 for measurement, 1 warming up for next measurement)
Lamp mode	EMISSION, NON-BGC, BGC-D ₂ , BGC-SR	
Data processing	Software requirements	Microsoft Windows 7 Professional / Vista Business / XP Professional
	Parameter setting	Wizard method
	Measurement mode	Flame continuous method, flame micro sampling method, furnace method, flame emission method
	Concentration computation mode	• Calibration curve method (select primary, secondary, tertiary) • Standard addition method, simple standard addition method (primary expression)
	Repeat analysis	Up to 20 repetitions. Mean value, standard deviation (SD) and coefficient of variation (RSD) display Automatic exclusion of deviant values by setting SD and %RSD
	Baseline correction	Automatic correction of baseline drift by offset correction in peak height / peak area modes.
	Signal processing segment setting	Signal processing segments can be changed in peak height / peak area modes.
	Sensitivity correction	Automatic calibration curve correction function using sensitivity monitoring
	Analog output	2 channels (atomic absorption/energy signal, background signal) Output range: 5.0, 2.5, 1.25, 0.625 Abs./V (each settable in 4 stages) Fixed at 1 V F.S. in EMISSION mode.
	Tabular data processing	Final concentration calculations based on sampled volume, dilution rate, fixed volume, and factor inputs
	Recall of parameters	Template functions available
	Procedure/result display	MRT (Measurement Results Table) worksheet
	Report generation	Summary report
	QA/QC	Select whether to continue or discontinue measurements based on results of evaluation on coefficient of correlation, %RSD, ICV-ICB, CCV-CCB, PB, LCS, SPK, PDS, and DUP.
Re-analysis	<ul style="list-style-type: none"> • Select whether on not to conduct re-analysis. • Automatic dilution and re-analysis of unknown samples via autosampler (flame micro sampling method, furnace method) 	
Digital recording	<ul style="list-style-type: none"> • Management by login ID and password • Control user access authority by user level • Log record • Audit trail • Electronic signatures 	
Power requirements	Choose from 100, 120, 220, or 230 VAC, 50/60 Hz (Power is required separately for the personal computer.)	
Dimensions and weight	<ul style="list-style-type: none"> ●AA-7000F/AAC: 700 W × 588 D × 714 H mm, 76 kg ●AA-7000G: 700 W × 580 D × 538 H mm, 66 kg (Protruding parts and optional equipment are not included.)	
Ambient temperature / humidity	10 to 35 °C, 20 to 80% (less than 70% when temperature is higher than 30 °C)	

Flame

Burner unit	Type	Air-cooled pre-mix type
	Burner head	Titanium 10 cm slot (5 cm titanium slot for N ₂ O-C ₂ H ₂ flame available as an option)
	Nebulizer	<ul style="list-style-type: none"> ●Pt-Ir capillary ●PTFE orifice ●ceramic impact bead (capable of handling hydrofluoric acid)
	Chamber	Engineering plastics
	Positioning	<ul style="list-style-type: none"> ●AA-7000F • Lateral/vertical manual adjustment ●AA-7000F/AAC • Automatic flame/furnace switching by motor • Automatic search of optimum burner height
	Angle adjustment	0 to 90° (Angle adjustment is not possible if the optional GFA-7000A is installed on the AA-7000F/AAC.)
Gas control	Type	Air-C ₂ H ₂ flame, N ₂ O-C ₂ H ₂ flame (Hydrogen flame is not applicable)
	Flow rate control	• Automatic fuel gas flow rate setting (0.1 L/min step) • Automatic search of optimum gas flow rate
	Safety measures	<ul style="list-style-type: none"> • Automatic gas leak check • Automatic Air-N₂O switching as C₂H₂ flow rate increases • Flame monitor • Prevention of wrong burner head use • Gas pressure monitor • Drain tank level monitor • Automatic flame extinction upon power outage or sudden power interruption • Automatic flame extinction via flame vibration sensor • Internal fan stop sensor

Furnace (GFA-7000A)

Heating temperature range	• Ambient to 3,000 °C
Heating control system	<ul style="list-style-type: none"> • Drying: Digital current control with automatic temperature calibration function • Ashing, Atomization: Digital temperature control via optical sensor
Setting heating conditions	<ul style="list-style-type: none"> • Maximum 20 stages • Heating mode: RAMP/STEP • Inner gas type: Dual automatic switching type • High-sensitivity mode setting • Enrichment in furnace: Maximum 20 times • Optimum temperature program search support function • Inner gas flow rate: 0 to 1.50 L/min
Safety measures	<ul style="list-style-type: none"> • Cooling water flow rate monitor • Gas pressure monitor • Overcurrent protection unit (double check by circuit protector and optical sensor) • Furnace block cooling check
Positioning	<ul style="list-style-type: none"> ●AA-7000G • Lateral/vertical manual adjustment ●AA-7000F/AAC • Automatic flame/furnace switching by motor
Power requirements	200, 220, 230, or 240 VAC ±5%, 7400 VA, 50/60 Hz
Dimensions and weight	260 W × 560 D × 510 H mm, 47 kg

Autosampler

Common Specifications

Control	RS-232C communication control from AA unit
Maximum reagent / sample positions	Reagents: 8 positions Samples: 60 positions (random access available with reagents or samples)
Rinse water bottle	2 L
Power requirements	Choose from 100, 120, 220, or 230 VAC, 50 VA, 50/60 Hz

Flame Continuous Method

Functions	Zero-point detection, auto diagnosis, auto rinse, random access
Sample volume	Sample vials: 15 mL, reagent vials: 53 mL
Nozzle rinse	Solvent rinse aspiration method
Dimensions and weight	Sampler: 340 W × 280 D × 270 H mm, 8 kg Controller (including stand): 260 W × 200 D × 320 H mm, 7 kg

Furnace Method / Flame Micro Sampling Method

Functions	Zero-point detection, auto diagnosis, auto rinse, auto mixing, random access
Sample volume	Sample vials: 2 mL, reagent vials: 20 mL
Nozzle rinse	Solvent rinse discharge method
Sampling functions	Dilution function, reagent addition function
Syringe	250 µL
Injection volume	2 to 90 µL
Repeatability	1%RSD (20 µL)
Carryover	Rinse port: Less than 0.0001 Mixing port: Less than 0.00001
Mixing port rinse	Solvent rinse discharge method, solvent discharge and rinse with next sample
Mixing function	Performed in mixing port. Maximum mixture volume: 0.6 mL
Maximum number of mixing reagents added	Up to 4 solutions Number of solutions possible for mixing · Calibration curve method: 5 solutions max. (sample + 4 types of reagents) · Standard addition method: 6 solutions max. (sample + standard solution + 4 types of reagents)
Auto dilution / re-analysis	For measurement result on unknown samples: · If extrapolation of calibration curve is possible: automatic calculation of dilution rate and dilution to bring concentration within calibration curve range · If extrapolation of calibration curve is not possible: dilution rate fixed at 10x
Dimensions and weight	Sampler (including sliding parts): 340 W × 280 D × 400 H mm, 11 kg Controller: 235 W × 110 D × 240 H mm (built into GFA-7000A), 6 kg

Required Software Operation Environment

Shimadzu recommends the PC and monitor in the PC Set for AA-7000 Series with WizAArd Software Pre-Installed. Purchase a printer separately. The personal computer and monitor specifications are as follows.

Operating system	Microsoft Windows 7 Professional (32bit) / Vista Business / XP Professional
CPU	Intel® Celeron 420 (1.60 GHz or higher) To use GFA-TV, Intel® Pentium DualCore E2180 (2 GHz) or higher is required.
RAM	1 GB or higher (Vista) or 512 MB or higher (XP) To use GFA-TV, 1 GB or higher (GFA-TV)
Monitor	XGA (1024 × 768 dots) or higher
Storage device	One CD-ROM drive (for installing a software) Requires 60 MB min. hard disk space for AA installation.
I/O port	One serial port (for AA control) USB 2.0 port (for GFA-TV)
Peripheral device	Monitor, keyboard, mouse, printer

* Notes

- The PC, monitor and printer are not included in the standard configuration. Prepare them separately.
- The ASC-7000, ASK-7000 and GFA-7000A are optional accessories.
- The separately available micro sampling kit is required for the flame micro sampling method.
- Microsoft Windows 7 Professional / Vista Business and XP Professional are registered trademarks of Microsoft Corp., U.S.A.
- The AA-7000 Series does not conform to IEC60601 — Medical Electrical Equipment.

Dimensions

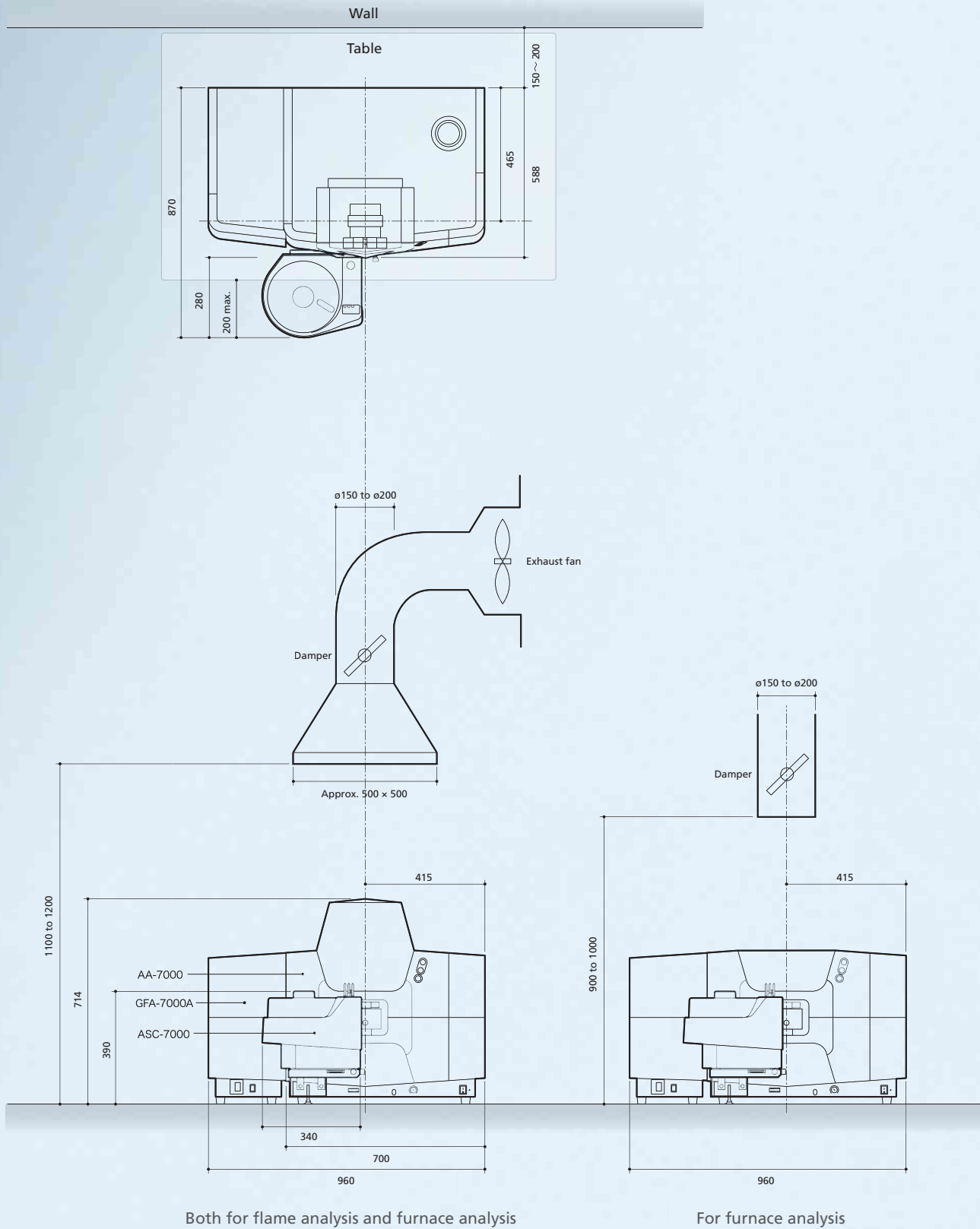

Both for flame analysis and furnace analysis

For furnace analysis

Above dimensions do not include PC or printer.

Unit: mm
S=1: 20

Make sure all required equipment is available before starting instrument installation. See the installation guidelines for details.

Example of recommended piping for the atomic absorption system

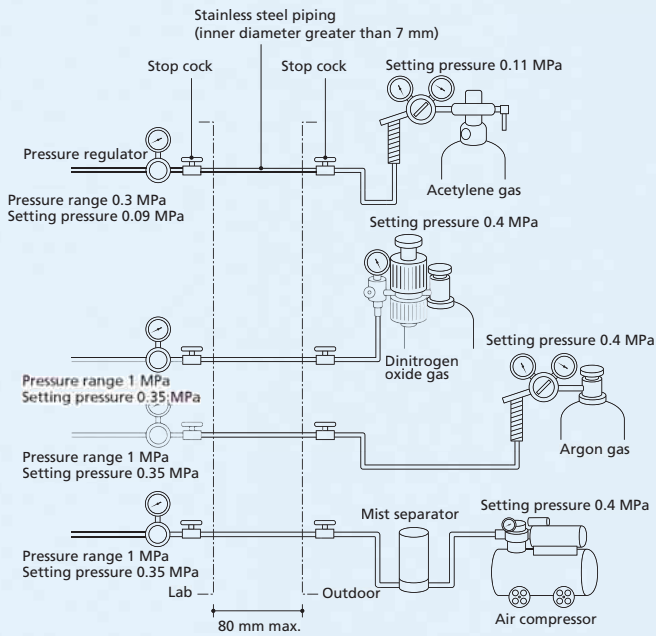

Operating environment	Temperature range	10 to 35 °C
	Humidity range	20 to 80% (less than 70% when temperature is higher than 30 °C)
Testing bench		1500 mm min. (W) × 700 mm min. (D)
		Withstand load: 200 kg ^{*1,2}
Gas tube	Material	Stainless ^{*3}
	Dimensions	7 mm min. I.D. × 80 mm min. (L)
Gas supply pressure (set secondary pressure)	Acetylene	Cylinder: 0.11 MPa Lab: 0.09 MPa
	Air	Compressor: 0.4 MPa Lab: 0.35 MPa
	Dinitrogen oxide	Cylinder: 0.4 MPa Lab: 0.35 MPa
	Argon	Cylinder: 0.4 MPa Lab: 0.35 MPa
Exhaust duct	Material	Stainless
	Dimensions	For flame: Approx. 500 mm W × 500 mm D For furnace: ø150 mm to ø200 mm
	Intake capacity	For flame: 600 to 1200 m ³ /hr For furnace: 10 to 180 m ³ /hr
Cooling water (GFA-7000A)		Cooling water circulation unit or tap-water equipment ^{*4}

*1 Atomic absorption spectrophotometer stand recommended

*2 Maintain a free maintenance space of 150 to 200 mm to the sides and rear of the instrument.

*3 Do not use pipes containing copper, silver, gold, mercury (or alloys containing these metals) as pipes for acetylene.

*4 If tap-water equipment is used, ensure that it meets the specifications below.

Compatible faucet	Faucet 13 or 12 to 15 mm O.D. rimmed faucet
Water temperature	10 to 30 °C
Water flow rate	0.6 to 1.5 L/min
Supply pressure	0.08 to 0.15 MPa ^{*5}
Supply port	7 mm min.

*5 If the supply pressure exceeds 0.17 MPa, use the optional Regulator ASSY.





Shimadzu Corporation
www.shimadzu.com/an/

Company names, product/service names and logos used in this publication are trademarks and trade names of Shimadzu Corporation or its affiliates, whether or not they are used with trademark symbol "TM" or "®". Third-party trademarks and trade names may be used in this publication to refer to either the entities or their products/services. Shimadzu disclaims any proprietary interest in trademarks and trade names other than its own.

For Research Use Only. Not for use in diagnostic procedures.
The contents of this publication are provided to you "as is" without warranty of any kind, and are subject to change without notice. Shimadzu does not assume any responsibility or liability for any damage, whether direct or indirect, relating to the use of this publication.